

Şirketimiz

Dünyada değişen iklim koşulları ve küresel ısınma nedeniyle yeryüzündeki suya olan ihtiyaç her geçen gün artmakta ve suyun değeri daha çok anlam kazanmaktadır. Ülkeler artık suyu korumak için üreticilerini ve çiftçilerini basınçsız sulama sistemlerine yönlendirerek önlemler almaya çalışmaktadırlar. İşte bu fikir ile sadece ülkemizde değil bütün dünyada su tasarrufunu sağlamak adına firmamız tarımsal sulama sistemlerinin üretimini yapmakta ve dünyada 50 den fazla ülkeye ihraç etmektedir.

Our company

Due to the changing climatic conditions in the world and global warming, the necessity of water in the earth is increasing day by day and the value of water is make sense more. Countries are now trying to take measures to protect water by directing their producers and farmers to non-pressurized irrigation systems. With this idea, our company produces agricultural irrigation systems and exports them to more than 50 countries all over the world in order to save water not only in our country but also all over the world.

NEDEN İRRITIME?

Alanında uzman personeli ile kaliteyi ön planda tutarak, değişim ve gelişimin bir işletme için gerekliliğine inanan İRRITIME ailesi içinde bulunduğu Pazar dinamiklerine, teknolojik ihtiyaçlara ve pazardaki değişimlere ayak uydurmak için gerekli adımları atmaktan geri durmaz.

Müşterilerimize ve işimize duyduğumuz saygının gereği olarak ürün ve hizmetlerimizin kalitesini müşterilerimizin beklentilerinin üstünde sunmaya gayret ederiz. Tüm faaliyetlerimizde çevre ve insan sağlığını korumayı gözetiriz. Tüm çalışanlarımıza ve paydaşlarımıza değer verir, adil yaklaşırız. Karşılıklı kazan kazan ilişkisini prensiplerimizin temeline koyar, verdiğimiz sözü tutmaya özen gösterir, siparişlerimizi eksiksiz ve zamanında teslim etmeye çalışırız.

WHY İRRITIME?

The İRRITIME family, which believes in the necessity of change and development for a business, by prioritizing quality with its expert staff, does not hesitate to take the necessary steps to keep up with the market dynamics, technological needs and changes in the market.

As a requirement of the respect we have for our customers and our business, we strive to offer the quality of our products and services above the expectations of our customers. We take care to protect the environment and human health in all our activities. We value all our employees and stakeholders and approach them fairly. We put the mutual win-win relationship on the basis of our principles, take care to keep our promises, and try to deliver our orders completely and on time.

*We are
more than 50 countries
all over the world...*





DAMLA SULAMA BORUSU3-29
DRIP IRRIGATION PIPE

DAMLAMA EK PARÇALARI30-46
DRIP IRRIGATION FITTINGS

MİKRO YAĞMURLAMA SİSTEMLERİ47-50
MICRO SPRINKLER

FİLTRE SİSTEMLERİ51-59
FILTER SYSTEMS

YAĞMURLAMA SİSTEMLERİ60-72
SPRINKLERS

PP DİŞLİ EK PARÇALAR73-78
PP THREADED FITTINGS

PP EK PARÇALAR79-92
PP COMPRESSION FITTINGS



STAR-R

16 MM

- Flat Topography
- Non-Pc
- Heavy Wall
- On Surface

Düz Arazi
Sabit Debili
Kalın Duvarlı
Toprak Üstü



Open Field
Crops



Row Crops



Tree and
orchard



Landscape



Greenhouse

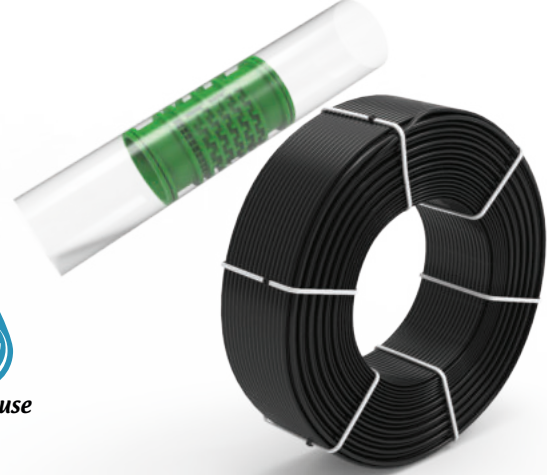

EKO STAR 0,9 mm DAMLA SULAMA BORUSU ECO STAR 0,9 mm DRIP IRRIGATION PIPE

Çap Diameter	Et Kalınlığı Wall Thickness	Debi Flow Rate	Paketleme Packaging	Kod Code	Damlama Aralığı Distance
16 mm	0,9 mm	2,4,8 Lt/sa lph	200 or 400 metre/top meter/roll	IR160920-2	20 cm
				IR160925-2	25 cm
				IR160930-2	30 cm
				IR160933-2	33 cm
				IR160940-2	40 cm
				IR160950-2	50 cm
				IR160960-2	60 cm
				IR160975-2	75 cm
IR160910-2	100 cm				

STAR 1,0 mm DAMLA SULAMA BORUSU STAR 1,0 mm DRIP IRRIGATION PIPE

Çap Diameter	Et Kalınlığı Wall Thickness	Debi Flow Rate	Paketleme Packaging	Kod Code	Damlama Aralığı Distance
16 mm	1,0 mm	2,4,8 Lt/sa lph	200 or 400 metre/top meter/roll	IR161020-4	20 cm
				IR161025-4	25 cm
				IR161030-4	30 cm
				IR161033-4	33 cm
				IR161040-4	40 cm
				IR161050-4	50 cm
				IR161060-4	60 cm
				IR161075-4	75 cm
IR161010-4	100 cm				

SÜPER STAR 1,1 mm DAMLA SULAMA BORUSU SUPER STAR 1,1 mm DRIP IRRIGATION PIPE

Çap Diameter	Et Kalınlığı Wall Thickness	Debi Flow Rate	Paketleme Packaging	Kod Code	Damlama Aralığı Distance
16 mm	1,1 mm	2,4,8 Lt/sa lph	200 or 400 metre/top meter/roll	IR161120-8	20 cm
				IR161125-8	25 cm
				IR161130-8	30 cm
				IR161133-8	33 cm
				IR161140-8	40 cm
				IR161150-8	50 cm
				IR161160-8	60 cm
				IR161175-8	75 cm
				IR161110-8	100 cm

- Please ask price for 200 mt rolls.



STAR-R

16 MM

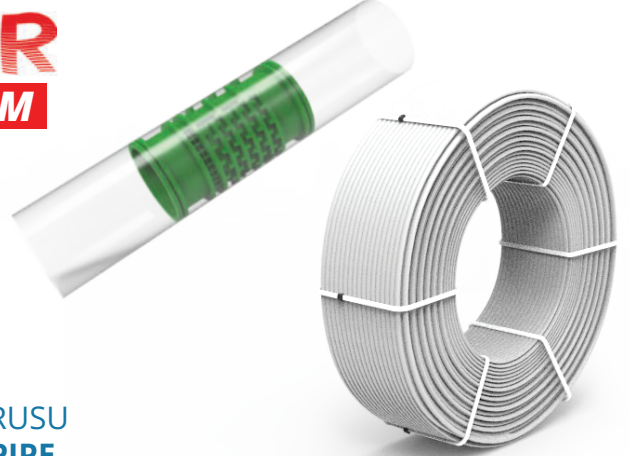
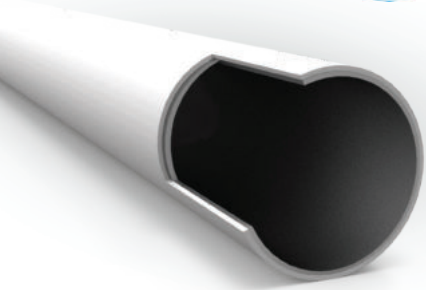

BEYAZ EKO STAR 0,9 mm DAMLA SULAMA BORUSU WHITE ECO STAR 0,9 mm DRIP IRRIGATION PIPE

Çap Diameter	Et Kalınlığı Wall Thickness	Debi Flow Rate	Paketleme Packaging	Kod Code	Damlama Aralığı Distance
16 mm	0,9 mm	2,4,8 Lt/sa lph	200 or 400 metre/top meter/roll	IRW160920-2	20 cm
				IRW160925-2	25 cm
				IRW160930-2	30 cm
				IRW160933-2	33 cm
				IRW160940-2	40 cm
				IRW160950-2	50 cm
				IRW160960-2	60 cm
				IRW160975-2	75 cm
IRW160910-2	100 cm				

BEYAZ STAR 1,0 mm DAMLA SULAMA BORUSU WHITE STAR 1,0 mm DRIP IRRIGATION PIPE

Çap Diameter	Et Kalınlığı Wall Thickness	Debi Flow Rate	Paketleme Packaging	Kod Code	Damlama Aralığı Distance
16 mm	1,0 mm	2,4,8 Lt/sa lph	200 or 400 metre/top meter/roll	IRW161020-4	20 cm
				IRW161025-4	25 cm
				IRW161030-4	30 cm
				IRW161033-4	33 cm
				IRW161040-4	40 cm
				IRW161050-4	50 cm
				IRW161060-4	60 cm
				IRW161075-4	75 cm
IRW161010-4	100 cm				

BEYAZ SÜPER STAR 1,1 mm DAMLA SULAMA BORUSU WHITE SUPER STAR 1,1 mm DRIP IRRIGATION PIPE

Çap Diameter	Et Kalınlığı Wall Thickness	Debi Flow Rate	Paketleme Packaging	Kod Code	Damlama Aralığı Distance
16 mm	1,1 mm	2,4,8 Lt/sa lph	200 or 400 metre/top meter/roll	IRW161120-8	20 cm
				IRW161125-8	25 cm
				IRW161130-8	30 cm
				IRW161133-8	33 cm
				IRW161140-8	40 cm
				IRW161150-8	50 cm
				IRW161160-8	60 cm
				IRW161175-8	75 cm
IRW161110-8	100 cm				

**Please ask price for 200 mt rolls.
Minimum Order Quantity 20.000 meters (50 Rolls)**



STAR-R

16 MM

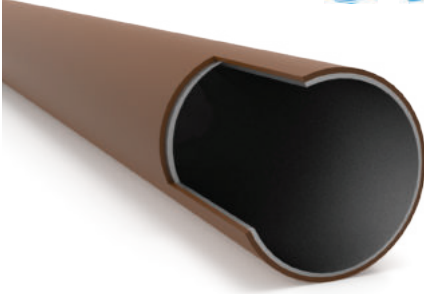

KAHVERENGİ EKO STAR 0,9 mm DAMLA SULAMA BORUSU BROWN ECO STAR 0,9 mm DRIP IRRIGATION PIPE

Çap Diameter	Et Kalınlığı Wall Thickness	Debi Flow Rate	Paketleme Packaging	Kod Code	Damlama Aralığı Distance
16 mm	0,9 mm	2,4,8 Lt/sa lph	200 or 400 metre/top meter/roll	IRB160920-2	20 cm
				IRB160925-2	25 cm
				IRB160930-2	30 cm
				IRB160933-2	33 cm
				IRB160940-2	40 cm
				IRB160950-2	50 cm
				IRB160960-2	60 cm
				IRB160975-2	75 cm
IRB160910-2	100 cm				

KAHVERENGİ STAR 1,0 mm DAMLA SULAMA BORUSU BROWN STAR 1,0 mm DRIP IRRIGATION PIPE

Çap Diameter	Et Kalınlığı Wall Thickness	Debi Flow Rate	Paketleme Packaging	Kod Code	Damlama Aralığı Distance
16 mm	1,0 mm	2,4,8 Lt/sa lph	200 or 400 metre/top meter/roll	IRB161020-4	20 cm
				IRB161025-4	25 cm
				IRB161030-4	30 cm
				IRB161033-4	33 cm
				IRB161040-4	40 cm
				IRB161050-4	50 cm
				IRB161060-4	60 cm
				IRB161075-4	75 cm
IRB161010-4	100 cm				

KAHVERENGİ SÜPER STAR 1,1 mm DAMLA SULAMA BORUSU BROWN SUPER STAR 1,1 mm DRIP IRRIGATION PIPE

Çap Diameter	Et Kalınlığı Wall Thickness	Debi Flow Rate	Paketleme Packaging	Kod Code	Damlama Aralığı Distance
16 mm	1,1 mm	2,4,8 Lt/sa lph	200 or 400 metre/top meter/roll	IRB161120-8	20 cm
				IRB161125-8	25 cm
				IRB161130-8	30 cm
				IRB161133-8	33 cm
				IRB161140-8	40 cm
				IRB161150-8	50 cm
				IRB161160-8	60 cm
				IRB161175-8	75 cm
IRB161110-8	100 cm				

**Please ask price for 200 mt rolls.
Minimum Order Quantity 20.000 meters (50 Rolls)**



STAR-R

16 MM



YEŞİL EKO STAR 0,9 mm DAMLA SULAMA BORUSU GREEN ECO STAR 0,9 mm DRIP IRRIGATION PIPE

Çap Diameter	Et Kalınlığı Wall Thickness	Debi Flow Rate	Paketleme Packaging	Kod Code	Damlama Aralığı Distance
16 mm	0,9 mm	2,4,8 Lt/sa lph	200 or 400 metre/top meter/roll	IRG160920-2	20 cm
				IRG160925-2	25 cm
				IRG160930-2	30 cm
				IRG160933-2	33 cm
				IRG160940-2	40 cm
				IRG160950-2	50 cm
				IRG160960-2	60 cm
IRG160975-2	75 cm				
IRG160910-2	100 cm				

YEŞİL STAR 1,0 mm DAMLA SULAMA BORUSU GREEN STAR 1,0 mm DRIP IRRIGATION PIPE

Çap Diameter	Et Kalınlığı Wall Thickness	Debi Flow Rate	Paketleme Packaging	Kod Code	Damlama Aralığı Distance
16 mm	1,0 mm	2,4,8 Lt/sa lph	200 or 400 metre/top meter/roll	IRG161020-4	20 cm
				IRG161025-4	25 cm
				IRG161030-4	30 cm
				IRG161033-4	33 cm
				IRG161040-4	40 cm
				IRG161050-4	50 cm
				IRG161060-4	60 cm
IRG161075-4	75 cm				
IRG161010-4	100 cm				

YEŞİL SÜPER STAR 1,1 mm DAMLA SULAMA BORUSU GREEN SUPER STAR 1,1 mm DRIP IRRIGATION PIPE

Çap Diameter	Et Kalınlığı Wall Thickness	Debi Flow Rate	Paketleme Packaging	Kod Code	Damlama Aralığı Distance
16 mm	1,1 mm	2,4,8 Lt/sa lph	200 or 400 metre/top meter/roll	IRG161120-8	20 cm
				IRG161125-8	25 cm
				IRG161130-8	30 cm
				IRG161133-8	33 cm
				IRG161140-8	40 cm
				IRG161150-8	50 cm
				IRG161160-8	60 cm
IRG161175-8	75 cm				
IRG161110-8	100 cm				

**Please ask price for 200 mt rolls.
Minimum Order Quantity 20.000 meters (50 Rolls)**



STAR-R 16 MM

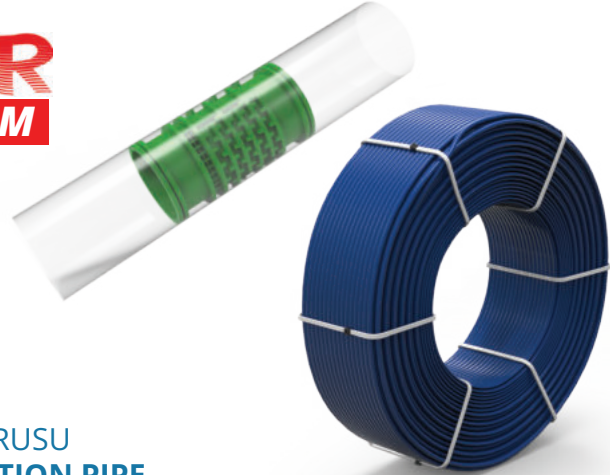
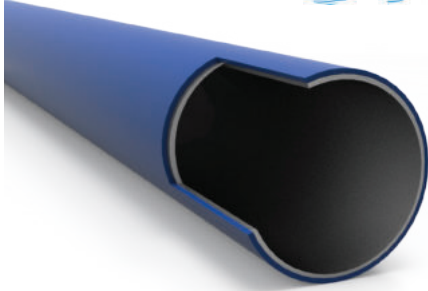

MAVİ EKO STAR 0,9 mm DAMLA SULAMA BORUSU DARK BLUE ECO STAR 0,9 mm DRIP IRRIGATION PIPE

Çap Diameter	Et Kalınlığı Wall Thickness	Debi Flow Rate	Paketleme Packaging	Kod Code	Damlama Aralığı Distance
16 mm	0,9 mm	2,4,8 Lt/sa lph	200 or 400 metre/top meter/roll	IRD160920-2	20 cm
				IRD160925-2	25 cm
				IRD160930-2	30 cm
				IRD160933-2	33 cm
				IRD160940-2	40 cm
				IRD160950-2	50 cm
				IRD160960-2	60 cm
				IRD160975-2	75 cm
IRD160910-2	100 cm				

MAVİ STAR 1,0 mm DAMLA SULAMA BORUSU DARK BLUE STAR 1,0 mm DRIP IRRIGATION PIPE

Çap Diameter	Et Kalınlığı Wall Thickness	Debi Flow Rate	Paketleme Packaging	Kod Code	Damlama Aralığı Distance
16 mm	1,0 mm	2,4,8 Lt/sa lph	200 or 400 metre/top meter/roll	IRD161020-4	20 cm
				IRD161025-4	25 cm
				IRD161030-4	30 cm
				IRD161033-4	33 cm
				IRD161040-4	40 cm
				IRD161050-4	50 cm
				IRD161060-4	60 cm
				IRD161075-4	75 cm
IRD161010-4	100 cm				

MAVİ SÜPER STAR 1,1 mm DAMLA SULAMA BORUSU DARK BLUE SUPER STAR 1,1 mm DRIP IRRIGATION PIPE

Çap Diameter	Et Kalınlığı Wall Thickness	Debi Flow Rate	Paketleme Packaging	Kod Code	Damlama Aralığı Distance
16 mm	1,1 mm	2,4,8 Lt/sa lph	200 or 400 metre/top meter/roll	IRD161120-8	20 cm
				IRD161125-8	25 cm
				IRD161130-8	30 cm
				IRD161133-8	33 cm
				IRD161140-8	40 cm
				IRD161150-8	50 cm
				IRD161160-8	60 cm
				IRD161175-8	75 cm
IRD161110-8	100 cm				

**Please ask price for 200 mt rolls.
Minimum Order Quantity 20.000 meters (50 Rolls)**



KÖR BORU (DÜZ BORU)
BLIND HOSE (PLAIN PIPE)

STAR-L

16 MM

BLACK



WHITE

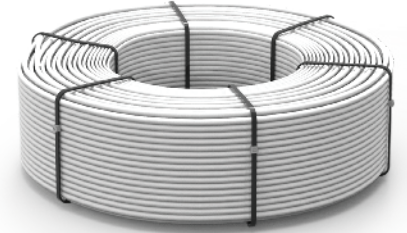

BROWN

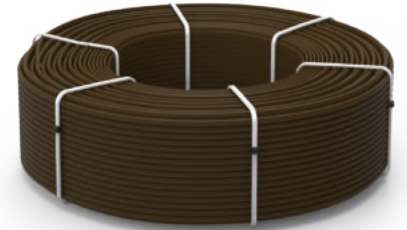

GREEN



BLUE



Kod Code	Çap Ø Diameter	Et Kalınlığı Wall Thickness	Rulo Uzunluğu Roll Length
IR1609	16 mm	0,9 mm	200 or 400 metre/top meter/roll
IR1610		1,0 mm	
IR1611		1,1 mm	
IR1612		1,2 mm	

Kod Code	Çap Ø Diameter	Et Kalınlığı Wall Thickness	Rulo Uzunluğu Roll Length
IRW1609	16 mm	0,9 mm	200 or 400 metre/top meter/roll
IRW1610		1,0 mm	
IRW1611		1,1 mm	
IRW1612		1,2 mm	

Kod Code	Çap Ø Diameter	Et Kalınlığı Wall Thickness	Rulo Uzunluğu Roll Length
IRB1609	16 mm	0,9 mm	200 or 400 metre/top meter/roll
IRB1610		1,0 mm	
IRB1611		1,1 mm	
IRB1612		1,2 mm	

Kod Code	Çap Ø Diameter	Et Kalınlığı Wall Thickness	Rulo Uzunluğu Roll Length
IRG1609	16 mm	0,9 mm	200 or 400 metre/top meter/roll
IRG1610		1,0 mm	
IRG1611		1,1 mm	
IRG1612		1,2 mm	

Kod Code	Çap Ø Diameter	Et Kalınlığı Wall Thickness	Rulo Uzunluğu Roll Length
IRD1609	16 mm	0,9 mm	200 or 400 metre/top meter/roll
IRD1610		1,0 mm	
IRD1611		1,1 mm	
IRD1612		1,2 mm	

Please ask price for 200 mt rolls.
Minimum Order Quantity 20.000 meters (50 Rolls)



STAR-R

16 MM

16 MM PIPES LOADING PLANS

20" DC CONTAINER

TOTAL QUANTITY
 $(20 \times 9) + (3 + 3) = 186$ rolls
 $186 \times 400 = 74.400$ meters

5 BOXES
100 boxes can fit in 20" DC Container.

7 ROLLS STAR-T
IRRITIME STAR-T Pipe
Midi Type Rolls
Mini Type Rolls
140 rolls can fit in 20" DC Container.

40" HC CONTAINER

TOTAL QUANTITY
 $(41 \times 10) + (3 + 3) = 416$ rolls
 $416 \times 400 = 166.400$ meters

6 BOXES
246 boxes can fit in 40" HC Container.

8 ROLLS STAR-T
IRRITIME STAR-T Pipe
Midi Type Rolls
Mini Type Rolls
328 rolls can fit in 40" HC Container.

TRUCK

TOTAL QUANTITY
 $48 \times 10 = 480$ rolls
 $480 \times 400 = 192.000$ meters

6 BOXES
288 boxes can fit in Truck

9 ROLLS STAR-T
IRRITIME STAR-T Pipe
Midi Type Rolls
Mini Type Rolls
432 rolls can fit in Truck



STAR-R
20 MM



STAR 20 mm DAMLA SULAMA BORUSU
STAR 20 mm DRIP IRRIGATION PIPE

Çap Diameter	Et Kalınlığı Wall Thickness	Debi Flow Rate	Paketleme Packaging	Kod Code	Damlama Aralığı Distance
20 mm	1,0 mm	2,4 Lt/sa lph	300 metre/top meter/roll	IR201020-2	20 cm
				IR201025-2	25 cm
				IR201030-2	30 cm
				IR201033-2	33 cm
				IR201040-2	40 cm
				IR201050-2	50 cm
				IR201060-2	60 cm
				IR201075-2	75 cm
IR201010-2	100 cm				

SÜPER STAR 1,1 mm DAMLA SULAMA BORUSU
SUPER STAR 1,1 mm DRIP IRRIGATION PIPE

Çap Diameter	Et Kalınlığı Wall Thickness	Debi Flow Rate	Paketleme Packaging	Kod Code	Damlama Aralığı Distance
20 mm	1,1 mm	2,4 Lt/sa lph	300 metre/top meter/roll	IR201120-4	20 cm
				IR201125-4	25 cm
				IR201130-4	30 cm
				IR201133-4	33 cm
				IR201140-4	40 cm
				IR201150-4	50 cm
				IR201160-4	60 cm
				IR201175-4	75 cm
IR201110-4	100 cm				



STAR-R 20 MM

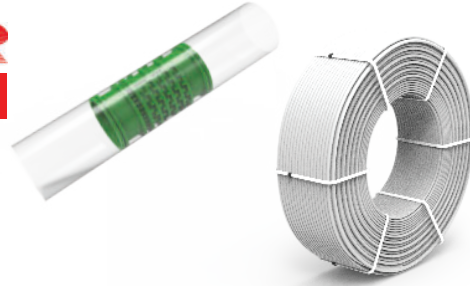

BEYAZ STAR 20 mm DAMLA SULAMA BORUSU WHITE STAR 20 mm DRIP IRRIGATION PIPE

Çap Diameter	Et Kalınlığı Wall Thickness	Debi Flow Rate	Paketleme Packaging	Kod Code	Damlama Aralığı Distance
20 mm	1,0 mm	2,4 Lt/sa lph	300 metre/top meter/roll	IRW201020-2	20 cm
				IRW201025-2	25 cm
				IRW201030-2	30 cm
				IRW201033-2	33 cm
				IRW201040-2	40 cm
				IRW201050-2	50 cm
				IRW201060-2	60 cm
				IRW201075-2	75 cm
IRW201010-2	100 cm				

BEYAZ SÜPER STAR 20 mm DAMLA SULAMA BORUSU WHITE SUPER STAR 20 mm DRIP IRRIGATION PIPE

Çap Diameter	Et Kalınlığı Wall Thickness	Debi Flow Rate	Paketleme Packaging	Kod Code	Damlama Aralığı Distance
20 mm	1,1 mm	2,4 Lt/sa lph	300 metre/top meter/roll	IRW201120-4	20 cm
				IRW201125-4	25 cm
				IRW201130-4	30 cm
				IRW201133-4	33 cm
				IRW201140-4	40 cm
				IRW201150-4	50 cm
				IRW201160-4	60 cm
				IRW201175-4	75 cm
				IRW201110-4	100 cm

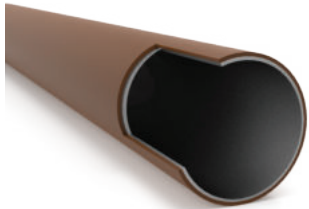

STAR-R 20 MM



KAHVERENGİ STAR 1,0 mm DAMLA SULAMA BORUSU BROWN STAR 1,0 mm DRIP IRRIGATION PIPE

Çap Diameter	Et Kalınlığı Wall Thickness	Debi Flow Rate	Paketleme Packaging	Kod Code	Damlama Aralığı Distance
20 mm	1,0 mm	2,4 Lt/sa lph	300 metre/top meter/roll	IRB201020-4	20 cm
				IRB201025-4	25 cm
				IRB201030-4	30 cm
				IRB201033-4	33 cm
				IRB201040-4	40 cm
				IRB201050-4	50 cm
				IRB201060-4	60 cm
				IRB201075-4	75 cm
IRB201010-4	100 cm				

KAHVERENGİ SÜPER STAR 1,1 mm DAMLA SULAMA BORUSU BROWN SUPER STAR 1,1 mm DRIP IRRIGATION PIPE

Çap Diameter	Et Kalınlığı Wall Thickness	Debi Flow Rate	Paketleme Packaging	Kod Code	Damlama Aralığı Distance
20 mm	1,1 mm	2,4 Lt/sa lph	300 metre/top meter/roll	IRB201120-8	20 cm
				IRB201125-8	25 cm
				IRB201130-8	30 cm
				IRB201133-8	33 cm
				IRB201140-8	40 cm
				IRB201150-8	50 cm
				IRB201160-8	60 cm
				IRB201175-8	75 cm
				IRB201110-8	100 cm

Minimum Order Quantity 15.000 meters (50 Rolls)



DAMLA SULAMA BORUSU DRIP IRRIGATION PIPE



Damla Sulama Borusu
Drip Irrigation Pipe

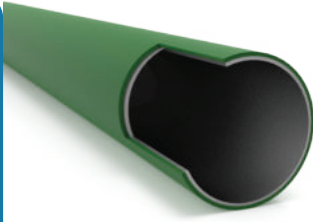

STAR-R
20 MM



YEŞİL STAR 1,0 mm DAMLA SULAMA BORUSU GREEN STAR 1,0 mm DRIP IRRIGATION PIPE

Çap Diameter	Et Kalınlığı Wall Thickness	Debi Flow Rate	Paketleme Packaging	Kod Code	Damlama Aralığı Distance
20 mm	1,0 mm	2,4 Lt/sa lph	300 metre/top meter/roll	IRG201020-2	20 cm
				IRG201025-2	25 cm
				IRG201030-2	30 cm
				IRG201033-2	33 cm
				IRG201040-2	40 cm
				IRG201050-2	50 cm
				IRG201060-2	60 cm
				IRG201075-2	75 cm
IRG201010-2	100 cm				

YEŞİL SÜPER STAR 1,1 mm DAMLA SULAMA BORUSU GREEN SUPER STAR 1,1 mm DRIP IRRIGATION PIPE

Çap Diameter	Et Kalınlığı Wall Thickness	Debi Flow Rate	Paketleme Packaging	Kod Code	Damlama Aralığı Distance
20 mm	1,1 mm	2,4 Lt/sa lph	300 metre/top meter/roll	IRG201120-4	20 cm
				IRG201125-4	25 cm
				IRG201130-4	30 cm
				IRG201133-4	33 cm
				IRG201140-4	40 cm
				IRG201150-4	50 cm
				IRG201160-4	60 cm
				IRG201175-4	75 cm
IRG201110-4	100 cm				

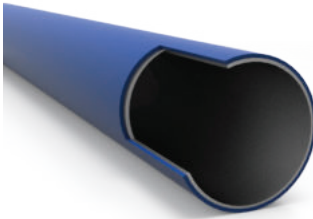

STAR-R
20 MM

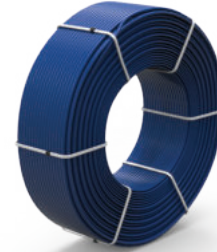

MAVİ STAR 1,0 mm DAMLA SULAMA BORUSU DARK BLUE STAR 1,0 mm DRIP IRRIGATION PIPE

Çap Diameter	Et Kalınlığı Wall Thickness	Debi Flow Rate	Paketleme Packaging	Kod Code	Damlama Aralığı Distance
20 mm	1,0 mm	2,4 Lt/sa lph	300 metre/top meter/roll	IRD201020-2	20 cm
				IRD201025-2	25 cm
				IRD201030-2	30 cm
				IRD201033-2	33 cm
				IRD201040-2	40 cm
				IRD201050-2	50 cm
				IRD201060-2	60 cm
				IRD201075-2	75 cm
IRD201010-2	100 cm				

MAVİ SÜPER STAR 1,1 mm DAMLA SULAMA BORUSU DARK BLUE SUPER STAR 1,1 mm DRIP IRRIGATION PIPE

Çap Diameter	Et Kalınlığı Wall Thickness	Debi Flow Rate	Paketleme Packaging	Kod Code	Damlama Aralığı Distance
20 mm	1,1 mm	2,4 Lt/sa lph	300 metre/top meter/roll	IRD201120-4	20 cm
				IRD201125-4	25 cm
				IRD201130-4	30 cm
				IRD201133-4	33 cm
				IRD201140-4	40 cm
				IRD201150-4	50 cm
				IRD201160-4	60 cm
				IRD201175-4	75 cm
IRD201110-4	100 cm				

Minimum Order Quantity 15.000 meters (50 Rolls)



**KÖR BORU (DÜZ BORU)
BLIND HOSE (PLAIN PIPE)**
STAR-L
20 MM
BLACK

WHITE

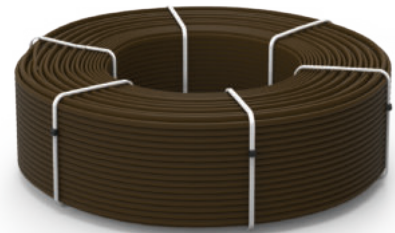
BROWN

GREEN

BLUE

Kod Code	Çap Ø Diameter	Et Kalınlığı Wall Thickness	Rulo Uzunluğu Roll Length
IR2010	20 mm	1,0 mm	300 metre/top meter/roll
IR2011		1,1 mm	
IR2012		1,2 mm	
IR2013		1,3 mm	

Kod Code	Çap Ø Diameter	Et Kalınlığı Wall Thickness	Rulo Uzunluğu Roll Length
IRW2010	20 mm	1,0 mm	300 metre/top meter/roll
IRW2011		1,1 mm	
IRW2012		1,2 mm	
IRW2013		1,3 mm	

Kod Code	Çap Ø Diameter	Et Kalınlığı Wall Thickness	Rulo Uzunluğu Roll Length
IRB2010	20 mm	1,0 mm	300 metre/top meter/roll
IRB2011		1,1 mm	
IRB2012		1,2 mm	
IRB2013		1,3 mm	

Kod Code	Çap Ø Diameter	Et Kalınlığı Wall Thickness	Rulo Uzunluğu Roll Length
IRG2010	20 mm	1,0 mm	300 metre/top meter/roll
IRG2011		1,1 mm	
IRG2012		1,2 mm	
IRG2013		1,3 mm	

Kod Code	Çap Ø Diameter	Et Kalınlığı Wall Thickness	Rulo Uzunluğu Roll Length
IRD2010	20 mm	1,0 mm	300 metre/top meter/roll
IRD2011		1,1 mm	
IRD2012		1,2 mm	
IRD2013		1,3 mm	

Minimum Order Quantity 15.000 meters (50 Rolls)



KÖR BORU (DÜZ BORU)
BLIND HOSE (PLAIN PIPE)

STAR-L

25 MM

BLACK

Kod Code	Çap Ø Diameter	Et Kalınlığı Wall Thickness	Rulo Uzunluğu Roll Length
IR2513	25 mm	1,3 mm	200 metre/top meter/roll
IR2514		1,4 mm	
IR2515		1,5 mm	



WHITE

Kod Code	Çap Ø Diameter	Et Kalınlığı Wall Thickness	Rulo Uzunluğu Roll Length
IRW2513	25 mm	1,3 mm	200 metre/top meter/roll
IRW2514		1,4 mm	
IRW2515		1,5 mm	

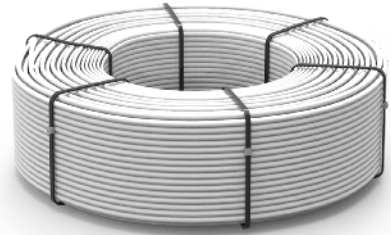

BROWN

Kod Code	Çap Ø Diameter	Et Kalınlığı Wall Thickness	Rulo Uzunluğu Roll Length
IRB2513	25 mm	1,3 mm	200 metre/top meter/roll
IRB2514		1,4 mm	
IRB2515		1,5 mm	

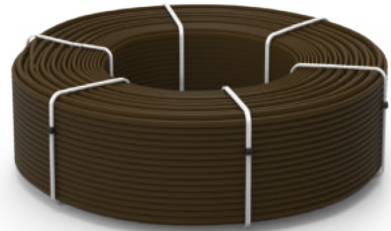

GREEN

Kod Code	Çap Ø Diameter	Et Kalınlığı Wall Thickness	Rulo Uzunluğu Roll Length
IRG2513	25 mm	1,3 mm	200 metre/top meter/roll
IRG2514		1,4 mm	
IRG2515		1,5 mm	



BLUE

Kod Code	Çap Ø Diameter	Et Kalınlığı Wall Thickness	Rulo Uzunluğu Roll Length
IRD2513	25 mm	1,3 mm	200 metre/top meter/roll
IRD2514		1,4 mm	
IRD2515		1,5 mm	



Minimum Order Quantity 10.000 meters (50 Rolls)



STAR-R

20 MM

20 MM PIPES LOADING PLANS

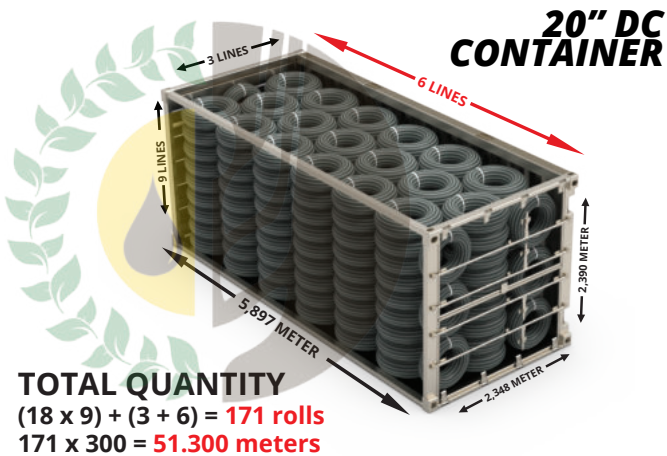

20" DC CONTAINER

3 LINES
6 LINES
9 LINES
5,897 METER
2,348 METER
2,390 METER

TOTAL QUANTITY
 $(18 \times 9) + (3 + 6) = 171$ rolls
 $171 \times 300 = 51.300$ meters

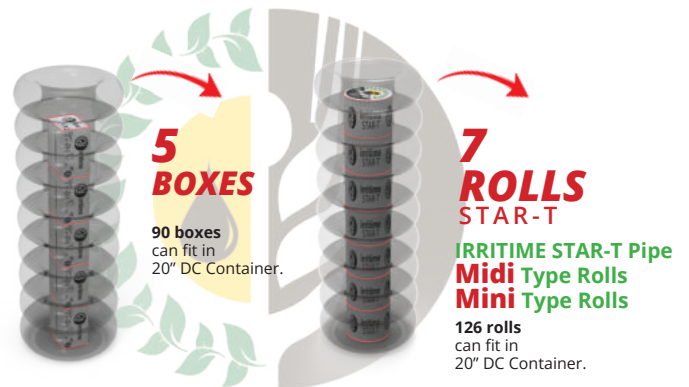

5 BOXES
90 boxes can fit in 20" DC Container.

7 ROLLS STAR-T
IRRITIME STAR-T Pipe
Midi Type Rolls
Mini Type Rolls
126 rolls can fit in 20" DC Container.

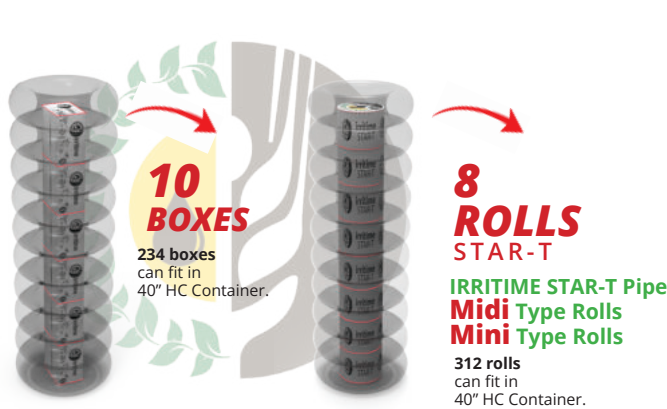

10 BOXES
234 boxes can fit in 40" HC Container.

8 ROLLS STAR-T
IRRITIME STAR-T Pipe
Midi Type Rolls
Mini Type Rolls
312 rolls can fit in 40" HC Container.

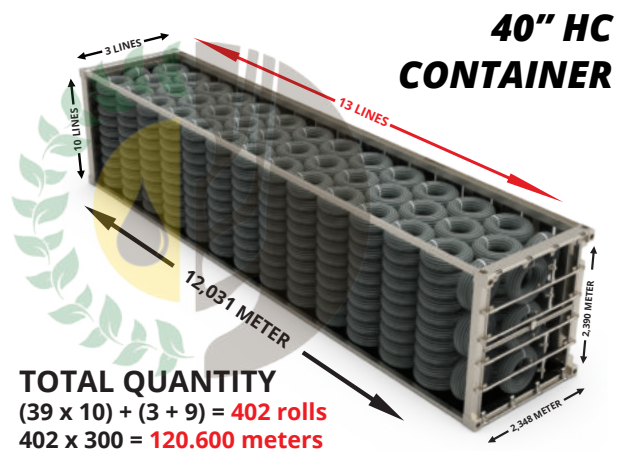

40" HC CONTAINER

3 LINES
10 LINES
13 LINES
12,031 METER
2,348 METER
2,390 METER

TOTAL QUANTITY
 $(39 \times 10) + (3 + 9) = 402$ rolls
 $402 \times 300 = 120.600$ meters

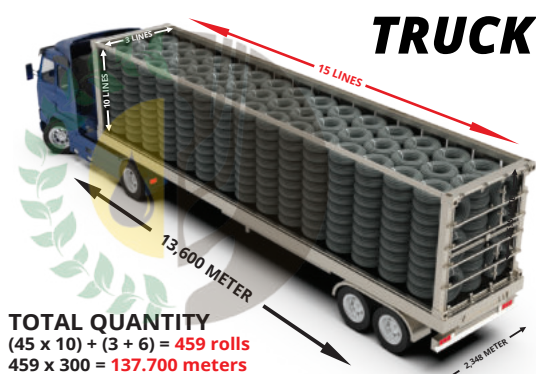

TRUCK

10 LINES
15 LINES
13,600 METER
2,468 METER
2,348 METER

TOTAL QUANTITY
 $(45 \times 10) + (3 + 6) = 459$ rolls
 $459 \times 300 = 137.700$ meters

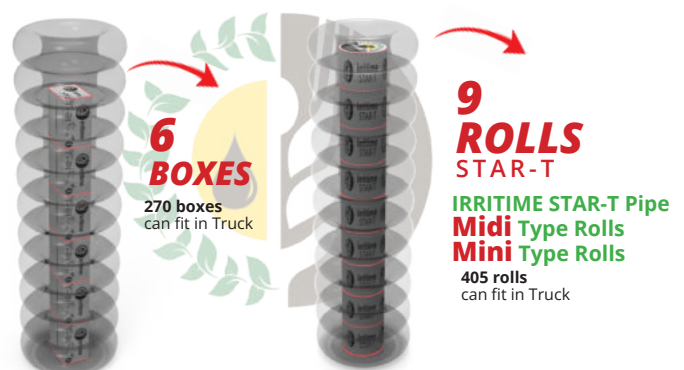

6 BOXES
270 boxes can fit in Truck

9 ROLLS STAR-T
IRRITIME STAR-T Pipe
Midi Type Rolls
Mini Type Rolls
405 rolls can fit in Truck



STAR-S

16 MM

Slope Topography / Eğimli Arazi
Flat Topography / Düz Arazi
SDI (Subsurface Drip Irigations) / TDS (toprak Altı Damla Sulama)
Anti-Siphon / Anti Sifon
PC (Pressure Compensating) / Basınç Ayarlı
Heavy Wall / Kalın Duvarlı



Open Field
Crops



Row Crops



Tree and
orchard



Landscape



Greenhouse

STAR 16 mm TOPRAK ALTI DAMLA SULAMA BORUSU Star 16 mm SUBSURFACE DRIPLINE

Çap Diameter	Et Kalınlığı Wall Thickness	Debi Flow Rate	Paketleme Packaging	Kod Code	Damlama Aralığı Distance
16 mm	0,9 mm	2,0 4,0 Lt/sa lph	200 or 400 metre/top meter/roll	IRS160920-2	20 cm
				IRS160925-2	25 cm
				IRS160930-2	30 cm
				IRS160933-2	33 cm
				IRS160940-2	40 cm
				IRS160950-2	50 cm
				IRS160960-2	60 cm
				IRS160975-2	75 cm
				IRS160910-2	100 cm

STAR 16 mm TOPRAK ALTI DAMLA SULAMA BORUSU STAR 16 mm SUBSURFACE DRIPLINE

Çap Diameter	Et Kalınlığı Wall Thickness	Debi Flow Rate	Paketleme Packaging	Kod Code	Damlama Aralığı Distance
16 mm	1,0 mm	1,6 2,0 4,0 Lt/sa lph	200 or 400 metre/top meter/roll	IRS161020-4	20 cm
				IRS161025-4	25 cm
				IRS161030-4	30 cm
				IRS161033-4	33 cm
				IRS161040-4	40 cm
				IRS161050-4	50 cm
				IRS161060-4	60 cm
				IRS161075-4	75 cm
				IRS161010-4	100 cm

PRESSURE-COMPENSATING, SELF-CLEANING, ANTI-SIPHON MECHANISM DRIPPER

The most durable Pressure Compensating dirpline, designed for steep and rocky terrain, permanent crops with long laterals, on surface and subsurface applications

Anti-Siphon (AS)

The Anti-Siphon (AS) system is a specially designed mechanism that prevents suction of dirt and impurities into the emitter. The AS feature enables STAR-S to be installed underground (SDI), perfectly maintaining its irrigation characteristics and its multi-year durability.

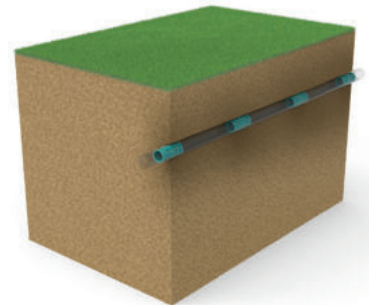

● Minimum Order Quantity 40.000 meters (100 Rolls)



STAR-P 16 MM

Slope Topography / Eğimli Arazi
Flat Topography / Düz Arazi
PC (Pressure Compensating) / Basınç Ayarlı
On Surface / Toprak Üstü
Heavy Wall / Kalın Duvarlı



STAR 16 mm BASINÇ AYARLI DAMLA SULAMA BORUSU STAR 16 mm PC DRIPLINE

Çap Diameter	Et Kalınlığı Wall Thickness	Debi Flow Rate	Paketleme Packaging	Kod Code	Damlama Aralığı Distance
16 mm	0,9 mm	1,6 2,0 4,0 Lt/sa lph	200 or 400 metre/top meter/roll	IPC160920-1,6	20 cm
				IPC160925-1,6	25 cm
				IPC160930-1,6	30 cm
				IPC160933-1,6	33 cm
				IPC160940-1,6	40 cm
				IPC160950-1,6	50 cm
				IPC160960-1,6	60 cm
				IPC160975-1,6	75 cm
IPC160910-1,6	100 cm				

STAR 16 mm BASINÇ AYARLI DAMLA SULAMA BORUSU STAR 16 mm PC DRIPLINE

Çap Diameter	Et Kalınlığı Wall Thickness	Debi Flow Rate	Paketleme Packaging	Kod Code	Damlama Aralığı Distance
16 mm	1,0 mm	1,6 2,0 4,0 Lt/sa lph	200 or 400 metre/top meter/roll	IPC161020-2	20 cm
				IPC161025-2	25 cm
				IPC161030-2	30 cm
				IPC161033-2	33 cm
				IPC161040-2	40 cm
				IPC161050-2	50 cm
				IPC161060-2	60 cm
				IPC161075-2	75 cm
IPC161010-2	100 cm				

STAR 20 mm BASINÇ AYARLI DAMLA SULAMA BORUSU STAR 20 mm PC DRIPLINE

Çap Diameter	Et Kalınlığı Wall Thickness	Debi Flow Rate	Paketleme Packaging	Kod Code	Damlama Aralığı Distance
20 mm	1,0 mm	2,0 4,0 Lt/sa lph	300 metre/top meter/roll	IPC201020-4	20 cm
				IPC201025-4	25 cm
				IPC201030-4	30 cm
				IPC201033-4	33 cm
				IPC201040-4	40 cm
				IPC201050-4	50 cm
				IPC201060-4	60 cm
				IPC201075-4	75 cm
IPC201010-4	100 cm				

- Please ask price for 200 mt rolls.
- Minimum Order Quantity 20.000 meters (50 Rolls)



STAR-P

16 MM

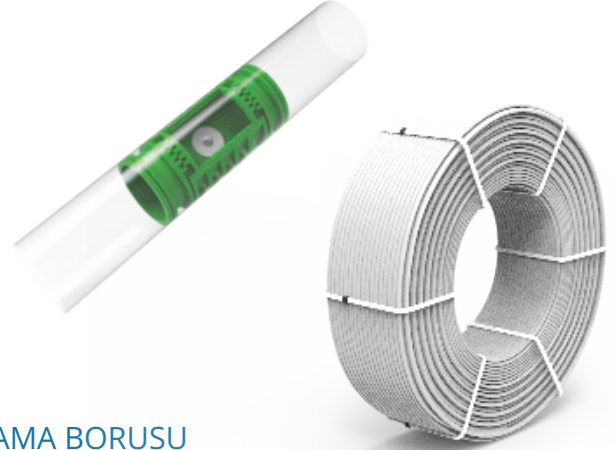

BEYAZ STAR 16 mm BASINÇ AYARLI DAMLA SULAMA BORUSU WHITE STAR 16 mm PC DRIPLINE

Çap Diameter	Et Kalınlığı Wall Thickness	Debi Flow Rate	Paketleme Packaging	Kod Code	Damlama Aralığı Distance
16 mm	0,9 mm	1,6 2,0 4,0 Lt/sa lph	200 or 400 metre/top meter/roll	IPCW160920-1,6	20 cm
				IPCW160925-1,6	25 cm
				IPCW160930-1,6	30 cm
				IPCW160933-1,6	33 cm
				IPCW160940-1,6	40 cm
				IPCW160950-1,6	50 cm
				IPCW160960-1,6	60 cm
				IPCW160975-1,6	75 cm
IPCW160910-1,6	100 cm				

BEYAZ STAR 16 mm BASINÇ AYARLI DAMLA SULAMA BORUSU WHITE STAR 16 mm PC DRIPLINE

Çap Diameter	Et Kalınlığı Wall Thickness	Debi Flow Rate	Paketleme Packaging	Kod Code	Damlama Aralığı Distance
16 mm	1,0 mm	1,6 2,0 4,0 Lt/sa lph	200 or 400 metre/top meter/roll	IPCW161020-2	20 cm
				IPCW161025-2	25 cm
				IPCW161030-2	30 cm
				IPCW161033-2	33 cm
				IPCW161040-2	40 cm
				IPCW161050-2	50 cm
				IPCW161060-2	60 cm
				IPCW161075-2	75 cm
IPCW161010-2	100 cm				

BEYAZ STAR 20 mm BASINÇ AYARLI DAMLA SULAMA BORUSU WHITE STAR 20 mm PC DRIPLINE

Çap Diameter	Et Kalınlığı Wall Thickness	Debi Flow Rate	Paketleme Packaging	Kod Code	Damlama Aralığı Distance
20 mm	1,0 mm	2,0 4,0 Lt/sa lph	300 metre/top meter/roll	IPCW201020-4	20 cm
				IPCW201025-4	25 cm
				IPCW201030-4	30 cm
				IPCW201033-4	33 cm
				IPCW201040-4	40 cm
				IPCW201050-4	50 cm
				IPCW201060-4	60 cm
				IPCW201075-4	75 cm
IPCW201010-4	100 cm				

- Please ask price for 200 mt rolls.
- Minimum Order Quantity 20.000 meters (50 Rolls)



STAR-P 16 MM

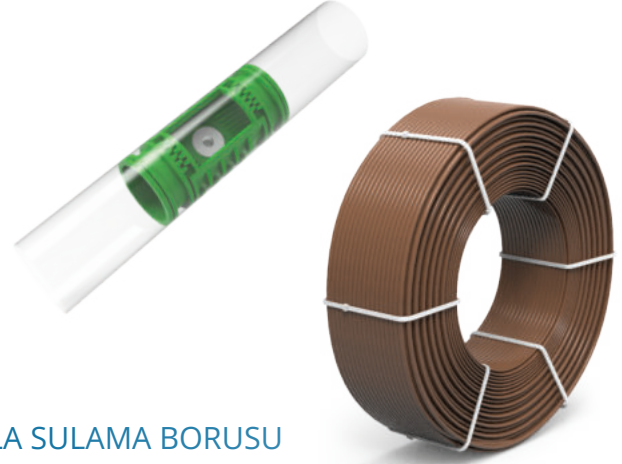

KAHVERENGİ STAR 16 mm BASINÇ AYARLI DAMLA SULAMA BORUSU BROWN STAR 16 mm PC DRIPLINE

Çap Diameter	Et Kalınlığı Wall Thickness	Debi Flow Rate	Paketleme Packaging	Kod Code	Damlama Aralığı Distance
16 mm	0,9 mm	1,6 2,0 4,0 Lt/sa lph	200 or 400 metre/top meter/roll	IPCB160920-1,6	20 cm
				IPCB160925-1,6	25 cm
				IPCB160930-1,6	30 cm
				IPCB160933-1,6	33 cm
				IPCB160940-1,6	40 cm
				IPCB160950-1,6	50 cm
				IPCB160960-1,6	60 cm
				IPCB160975-1,6	75 cm
IPCB160910-1,6	100 cm				

KAHVERENGİ STAR 16 mm BASINÇ AYARLI DAMLA SULAMA BORUSU BROWN STAR 16 mm PC DRIPLINE

Çap Diameter	Et Kalınlığı Wall Thickness	Debi Flow Rate	Paketleme Packaging	Kod Code	Damlama Aralığı Distance
16 mm	1,0 mm	1,6 2,0 4,0 Lt/sa lph	200 or 400 metre/top meter/roll	IPCB161020-2	20 cm
				IPCB161025-2	25 cm
				IPCB161030-2	30 cm
				IPCB161033-2	33 cm
				IPCB161040-2	40 cm
				IPCB161050-2	50 cm
				IPCB161060-2	60 cm
				IPCB161075-2	75 cm
IPCB161010-2	100 cm				

KAHVERENGİ STAR 20 mm BASINÇ AYARLI DAMLA SULAMA BORUSU BROWN STAR 20 mm PC DRIPLINE

Çap Diameter	Et Kalınlığı Wall Thickness	Debi Flow Rate	Paketleme Packaging	Kod Code	Damlama Aralığı Distance
20 mm	1,0 mm	2,0 4,0 Lt/sa lph	300 metre/top meter/roll	IPCB201020-4	20 cm
				IPCB201025-4	25 cm
				IPCB201030-4	30 cm
				IPCB201033-4	33 cm
				IPCB201040-4	40 cm
				IPCB201050-4	50 cm
				IPCB201060-4	60 cm
				IPCB201075-4	75 cm
IPCB201010-4	100 cm				

- Please ask price for 200 mt rolls.
- Minimum Order Quantity 20.000 meters (50 Rolls)



STAR-P
16 MM



YEŞİL STAR 16 mm BASINÇ AYARLI DAMLA SULAMA BORUSU
GREEN STAR 16 mm PC DRIPLINE

Çap Diameter	Et Kalınlığı Wall Thickness	Debi Flow Rate	Paketleme Packaging	Kod Code	Damlama Aralığı Distance
16 mm	0,9 mm	1,6 2,0 4,0 Lt/sa lph	200 or 400 metre/top meter/roll	IPCG160920-1,6	20 cm
				IPCG160925-1,6	25 cm
				IPCG160930-1,6	30 cm
				IPCG160933-1,6	33 cm
				IPCG160940-1,6	40 cm
				IPCG160950-1,6	50 cm
				IPCG160960-1,6	60 cm
				IPCG160975-1,6	75 cm
IPCG160910-1,6	100 cm				

YEŞİL STAR 16 mm BASINÇ AYARLI DAMLA SULAMA BORUSU
GREEN STAR 16 mm PC DRIPLINE

Çap Diameter	Et Kalınlığı Wall Thickness	Debi Flow Rate	Paketleme Packaging	Kod Code	Damlama Aralığı Distance
16 mm	1,0 mm	1,6 2,0 4,0 Lt/sa lph	200 or 400 metre/top meter/roll	IPCG161020-2	20 cm
				IPCG161025-2	25 cm
				IPCG161030-2	30 cm
				IPCG161033-2	33 cm
				IPCG161040-2	40 cm
				IPCG161050-2	50 cm
				IPCG161060-2	60 cm
				IPCG161075-2	75 cm
IPCG161010-2	100 cm				

YEŞİL STAR 20 mm BASINÇ AYARLI DAMLA SULAMA BORUSU
GREEN STAR 20 mm PC DRIPLINE

Çap Diameter	Et Kalınlığı Wall Thickness	Debi Flow Rate	Paketleme Packaging	Kod Code	Damlama Aralığı Distance
20 mm	1,0 mm	2,0 4,0 Lt/sa lph	300 metre/top meter/roll	IPCG201020-4	20 cm
				IPCG201025-4	25 cm
				IPCG201030-4	30 cm
				IPCG201033-4	33 cm
				IPCG201040-4	40 cm
				IPCG201050-4	50 cm
				IPCG201060-4	60 cm
				IPCG201075-4	75 cm
IPCG201010-4	100 cm				

- Please ask price for 200 mt rolls.
- Minimum Order Quantity 20.000 meters (50 Rolls)



STAR-P

16 MM

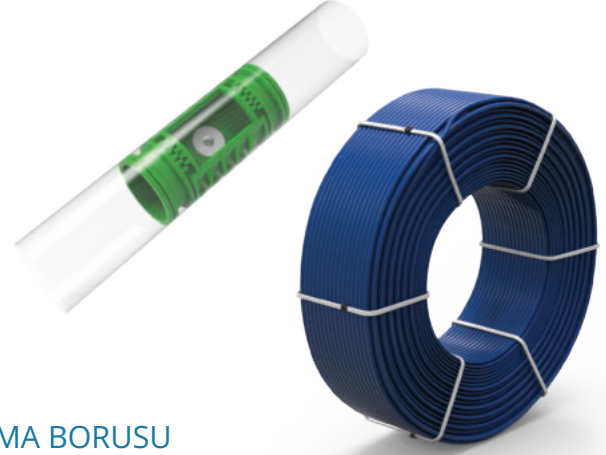

MAVİ STAR 16 mm BASINÇ AYARLI DAMLA SULAMA BORUSU DARK BLUE STAR 16 mm PC DRIPLINE

Çap Diameter	Et Kalınlığı Wall Thickness	Debi Flow Rate	Paketleme Packaging	Kod Code	Damlama Aralığı Distance
16 mm	0,9 mm	1,6 2,0 4,0 Lt/sa lph	200 or 400 metre/top meter/roll	IPCD160920-1,6	20 cm
				IPCD160925-1,6	25 cm
				IPCD160930-1,6	30 cm
				IPCD160933-1,6	33 cm
				IPCD160940-1,6	40 cm
				IPCD160950-1,6	50 cm
				IPCD160960-1,6	60 cm
				IPCD160975-1,6	75 cm
IPCD160910-1,6	100 cm				

MAVİ STAR 16 mm BASINÇ AYARLI DAMLA SULAMA BORUSU DARK BLUE STAR 16 mm PC DRIPLINE

Çap Diameter	Et Kalınlığı Wall Thickness	Debi Flow Rate	Paketleme Packaging	Kod Code	Damlama Aralığı Distance
16 mm	1,0 mm	1,6 2,0 4,0 Lt/sa lph	200 or 400 metre/top meter/roll	IPCD161020-2	20 cm
				IPCD161025-2	25 cm
				IPCD161030-2	30 cm
				IPCD161033-2	33 cm
				IPCD161040-2	40 cm
				IPCD161050-2	50 cm
				IPCD161060-2	60 cm
				IPCD161075-2	75 cm
IPCD161010-2	100 cm				

MAVİ STAR 20 mm BASINÇ AYARLI DAMLA SULAMA BORUSU DARK BLUE STAR 20 mm PC DRIPLINE

Çap Diameter	Et Kalınlığı Wall Thickness	Debi Flow Rate	Paketleme Packaging	Kod Code	Damlama Aralığı Distance
20 mm	1,0 mm	2,0 4,0 Lt/sa lph	300 metre/top meter/roll	IPCD201020-4	20 cm
				IPCD201025-4	25 cm
				IPCD201030-4	30 cm
				IPCD201033-4	33 cm
				IPCD201040-4	40 cm
				IPCD201050-4	50 cm
				IPCD201060-4	60 cm
				IPCD201075-4	75 cm
IPCD201010-4	100 cm				

- Please ask price for 200 mt rolls.
- Minimum Order Quantity 20.000 meters (50 Rolls)



DAMLA SULAMA BORUSU DRIP IRRIGATION PIPE



Damla Sulama Borusu
Drip Irrigation Pipe



Flat Topography / Düz Arazi
Non - Pc / Sabit Debili
Thin and Medium Wall / İnce ve Orta Duvarlı
On Surface / Toprak Üstü



STAR-T mini

MİNİ STAR DAMLA SULAMA BORUSU 6 MİL MINI STAR T-TAPE DRIP PIPE 6 MIL

Çap Diameter	Et Kalınlığı Wall Thickness	Debi Flow Rate	Paketleme Packaging	Kod Code	Damlama Aralığı Distance
16 mm	6 mil (0,15mm)	1,0 1,6 2,2 3,5 Lt/h	500 metre/top meter/roll	IRN171510-1	10 cm
				IRN171515-1	15 cm
				IRN171520-1	20 cm
				IRN171525-1	25 cm
				IRN171530-1	30 cm
				IRN171533-1	33 cm
				IRN171540-1	40 cm
				IRN171550-1	50 cm
IRN171560-1	60 cm				

MİNİ STAR DAMLA SULAMA BORUSU 8 MİL MINI STAR T-TAPE DRIP PIPE 8 MIL

Çap Diameter	Et Kalınlığı Wall Thickness	Debi Flow Rate	Paketleme Packaging	Kod Code	Damlama Aralığı Distance
16 mm	8 mil (0,20mm)	1,0 1,6 2,2 3,5 Lt/h	500 metre/top meter/roll	IRN172010-1	10 cm
				IRN172015-1	15 cm
				IRN172020-1	20 cm
				IRN172025-1	25 cm
				IRN172030-1	30 cm
				IRN172033-1	33 cm
				IRN172040-1	40 cm
				IRN172050-1	50 cm
IRN172060-1	60 cm				

MİNİ STAR DAMLA SULAMA BORUSU 10 MİL MINI STAR T-TAPE DRIP PIPE 10 MIL

Çap Diameter	Et Kalınlığı Wall Thickness	Debi Flow Rate	Paketleme Packaging	Kod Code	Damlama Aralığı Distance
16 mm	10 mil (0,25mm)	1,0 1,6 2,2 3,5 Lt/h	400 metre/top meter/roll	IRN172510-1	10 cm
				IRN172515-1	15 cm
				IRN172520-1	20 cm
				IRN172525-1	25 cm
				IRN172530-1	30 cm
				IRN172533-1	33 cm
				IRN172540-1	40 cm
				IRN172550-1	50 cm
IRN172560-1	60 cm				





STAR-T

mini

MİNİ STAR DAMLA SULAMA BORUSU 12 MİL MINI STAR T-TAPE DRIP PIPE 12 MIL

Çap Diameter	Et Kalınlığı Wall Thickness	Debi Flow Rate	Paketleme Packaging	Kod Code	Damlama Aralığı Distance
16 mm	12 mil (0,30 mm)	1,0 1,6 2,2 3,5 Lt/h	350 metre/top meter/roll	IRN173010-1	10 cm
				IRN173015-1	15 cm
				IRN173020-1	20 cm
				IRN173025-1	30 cm
				IRN173030-1	30 cm
				IRN173033-1	33 cm
				IRN173040-1	40 cm
				IRN173050-1	50 cm
IRN173060-1	60 cm				

MİNİ STAR DAMLA SULAMA BORUSU 16 MİL MINI STAR T-TAPE DRIP PIPE 16 MIL

Çap Diameter	Et Kalınlığı Wall Thickness	Debi Flow Rate	Paketleme Packaging	Kod Code	Damlama Aralığı Distance
16 mm	16 mil (0,40 mm)	1,0 1,6 2,2 3,5 Lt/h	300 metre/top meter/roll	IRN174010-1	10 cm
				IRN174015-1	15 cm
				IRN174020-1	20 cm
				IRN174025-1	30 cm
				IRN174030-1	30 cm
				IRN174033-1	33 cm
				IRN174040-1	40 cm
				IRN174050-1	50 cm
IRN174060-1	60 cm				

PALLET LOADING PLAN





Flat Topography / Düz Arazi
Non - Pc / Sabit Debili
Thin and Medium Wall / İnce ve Orta Duvarlı
On Surface / Toprak Üstü

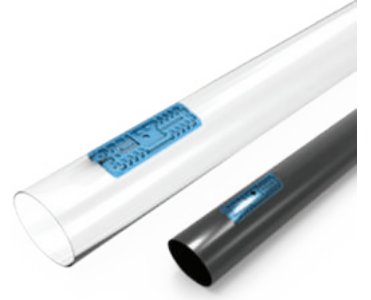

STAR-T MIDI

MİDİ STAR DAMLA SULAMA BORUSU 6 MİL MIDI STAR T-TAPE DRIP PIPE 6 MIL

Çap Diameter	Et Kalınlığı Wall Thickness	Debi Flow Rate	Paketleme Packaging	Kod Code	Damlama Aralığı Distance
16 mm	6 mil (0,15mm)	1,0 1,6 2,2 3,5 Lt/h	1.000 metre/top meter/roll	IRD171510-1	10 cm
				IRD171515-1	15 cm
				IRD171520-1	20 cm
				IRD171525-1	25 cm
				IRD171530-1	30 cm
				IRD171533-1	33 cm
				IRD171540-1	40 cm
				IRD171550-1	50 cm
IRD171560-1	60 cm				

MİDİ STAR DAMLA SULAMA BORUSU 8 MİL MIDI STAR T-TAPE DRIP PIPE 8 MIL

Çap Diameter	Et Kalınlığı Wall Thickness	Debi Flow Rate	Paketleme Packaging	Kod Code	Damlama Aralığı Distance
16 mm	8 mil (0,20mm)	1,0 1,6 2,2 3,5 Lt/h	1.000 metre/top meter/roll	IRD172010-1	10 cm
				IRD172015-1	15 cm
				IRD172020-1	20 cm
				IRD172025-1	25 cm
				IRD172030-1	30 cm
				IRD172033-1	33 cm
				IRD172040-1	40 cm
				IRD172050-1	50 cm
IRD172060-1	60 cm				

MİDİ STAR DAMLA SULAMA BORUSU 10 MİL MIDI STAR T-TAPE DRIP PIPE 10 MIL

Çap Diameter	Et Kalınlığı Wall Thickness	Debi Flow Rate	Paketleme Packaging	Kod Code	Damlama Aralığı Distance
16 mm	10 mil (0,25mm)	1,0 1,6 2,2 3,5 Lt/h	800 metre/top meter/roll	IRD172510-1	10 cm
				IRD172515-1	15 cm
				IRD172520-1	20 cm
				IRD172525-1	25 cm
				IRD172530-1	30 cm
				IRD172533-1	33 cm
				IRD172540-1	40 cm
				IRD172550-1	50 cm
IRD172560-1	60 cm				



STAR-T

MIDI

MİDİ STAR DAMLA SULAMA BORUSU 12 MİL MIDI STAR T-TAPE DRIP PIPE 12 MIL

Çap Diameter	Et Kalınlığı Wall Thickness	Debi Flow Rate	Paketleme Packaging	Kod Code	Damlama Aralığı Distance
16 mm	12 mil (0,30 mm)	1,0 1,6 2,2 3,5 Lt/h	700 metre/top meter/roll	IRD173010-1	10 cm
				IRD173015-1	15 cm
				IRD173020-1	20 cm
				IRD173025-1	25 cm
				IRD173030-1	30 cm
				IRD173033-1	33 cm
				IRD173040-1	40 cm
				IRD173050-1	50 cm
IRD173060-1	60 cm				

MİDİ STAR DAMLA SULAMA BORUSU 16 MİL MIDI STAR T-TAPE DRIP PIPE 16 MIL

Çap Diameter	Et Kalınlığı Wall Thickness	Debi Flow Rate	Paketleme Packaging	Kod Code	Damlama Aralığı Distance
16 mm	16 mil (0,40 mm)	1,0 1,6 2,2 3,5 Lt/h	600 metre/top meter/roll	IRD174010-1	10 cm
				IRD174015-1	15 cm
				IRD174020-1	20 cm
				IRD174025-1	25 cm
				IRD174030-1	30 cm
				IRD174033-1	33 cm
				IRD174040-1	40 cm
				IRD174050-1	50 cm
IRD174060-1	60 cm				

PALLET LOADING PLAN





Flat Topography / Düz Arazi
Non - Pc / Sabit Debili
Thin and Medium Wall / İnce ve Orta Duvarlı
On Surface / Toprak Üstü



STAR-T MAXI

MAXİ STAR DAMLA SULAMA BORUSU 6 MİL MAXI STAR T-TAPE DRIP PIPE 6 MIL

Çap Diameter	Et Kalınlığı Wall Thickness	Debi Flow Rate	Paketleme Packaging	Kod Code	Damlama Aralığı Distance
16 mm	6 mil (0,15mm)	1,0 1,6 2,2 3,5 Lt/h	2.500 metre/top meter/roll	IRX171510-1	10 cm
				IRX171515-1	15 cm
				IRX171520-1	20 cm
				IRX171525-1	25 cm
				IRX171530-1	30 cm
				IRX171533-1	33 cm
				IRX171540-1	40 cm
				IRX171550-1	50 cm
IRX171560-1	60 cm				

MAXİ STAR DAMLA SULAMA BORUSU 8 MİL MAXI STAR T-TAPE DRIP PIPE 8 MIL

Çap Diameter	Et Kalınlığı Wall Thickness	Debi Flow Rate	Paketleme Packaging	Kod Code	Damlama Aralığı Distance
16 mm	8 mil (0,20mm)	1,0 1,6 2,2 3,5 Lt/h	2.300 metre/top meter/roll	IRX172010-1	10 cm
				IRX172015-1	15 cm
				IRX172020-1	20 cm
				IRX172025-1	25 cm
				IRX172030-1	30 cm
				IRX172033-1	33 cm
				IRX172040-1	40 cm
				IRX172050-1	50 cm
IRX172060-1	60 cm				

MAXİ STAR DAMLA SULAMA BORUSU 10 MİL MAXI STAR T-TAPE DRIP PIPE 10 MIL

Çap Diameter	Et Kalınlığı Wall Thickness	Debi Flow Rate	Paketleme Packaging	Kod Code	Damlama Aralığı Distance
16 mm	10 mil (0,25mm)	1,0 1,6 2,2 3,5 Lt/h	2.000 metre/top meter/roll	IRX172510-1	10 cm
				IRX172515-1	15 cm
				IRX172520-1	20 cm
				IRX172525-1	25 cm
				IRX172530-1	30 cm
				IRX172533-1	33 cm
				IRX172540-1	40 cm
				IRX172550-1	50 cm
IRX172560-1	60 cm				



STAR-T

MAXI

MAXI STAR DAMLA SULAMA BORUSU 12 MİL MAXI STAR T-TAPE DRIP PIPE 12 MIL

Çap Diameter	Et Kalınlığı Wall Thickness	Debi Flow Rate	Paketleme Packaging	Kod Code	Damlama Aralığı Distance
16 mm	12 mil (0,30 mm)	1,0 1,6 2,2 3,5 Lt/h	1.800 metre/top meter/roll	IRX173010-1	10 cm
				IRX173015-1	15 cm
				IRX173020-1	20 cm
				IRX173025-1	30 cm
				IRX173030-1	30 cm
				IRX173033-1	33 cm
				IRX173040-1	40 cm
				IRX173050-1	50 cm
IRX173060-1	60 cm				

MAXI STAR DAMLA SULAMA BORUSU 16 MİL MAXI STAR T-TAPE DRIP PIPE 16 MIL

Çap Diameter	Et Kalınlığı Wall Thickness	Debi Flow Rate	Paketleme Packaging	Kod Code	Damlama Aralığı Distance
16 mm	16 mil (0,40 mm)	1,0 1,6 2,2 3,5 Lt/h	1.500 metre/top meter/roll	IRX174010-1	10 cm
				IRX174015-1	15 cm
				IRX174020-1	20 cm
				IRX174025-1	30 cm
				IRX174030-1	30 cm
				IRX174033-1	33 cm
				IRX174040-1	40 cm
				IRX174050-1	50 cm
IRX174060-1	60 cm				

22 mm MAXI STAR DAMLA SULAMA BORUSU 22 mm MAXI STAR T-TAPE DRIP PIPE

Çap Diameter	Et Kalınlığı Wall Thickness	Debi Flow Rate	Paketleme Packaging	Kod Code	Damlama Aralığı Distance
22 mm	10 mil (0,25mm)	1,0 1,6 2,2 Lt/h	1.400 metre/top meter/roll	IR222520-1	20 cm
				IR222525-1	25 cm
				IR222530-1	30 cm
	12 mil (0,30mm)		1.200 metre/top meter/roll	IR223020-2	20 cm
				IR223025-2	25 cm
				IR223030-2	30 cm

25 mm MAXI STAR DAMLA SULAMA BORUSU 25 mm MAXI STAR T-TAPE DRIP PIPE

Çap Diameter	Et Kalınlığı Wall Thickness	Debi Flow Rate	Paketleme Packaging	Kod Code	Damlama Aralığı Distance
25 mm	12 mil (0,30mm)	1,0 1,6 2,2 Lt/h	1.000 metre/top meter/roll	IR253020-1	20 cm
				IR253025-1	25 cm
				IR253030-1	30 cm



STAR-T MAXI LOADING PROGRAM

WITH PALLET

20" DC CONTAINER

WITHOUT PALLET

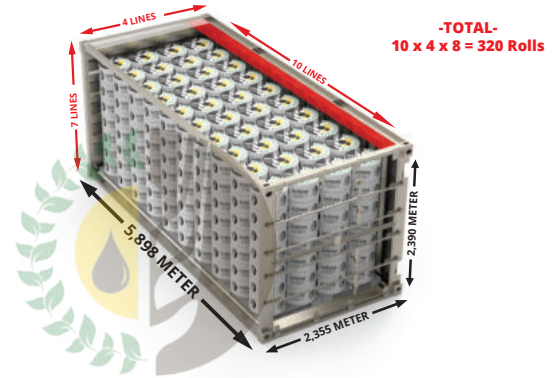
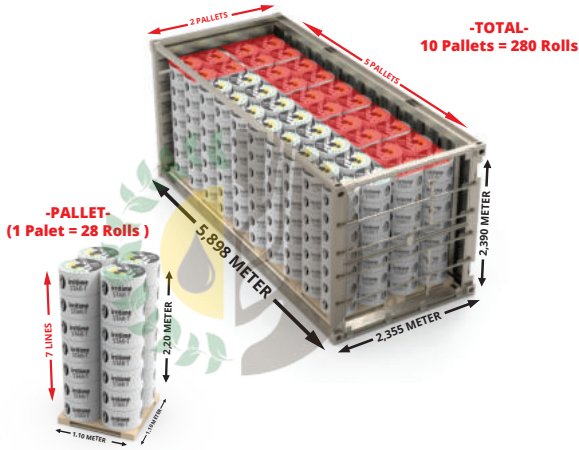

40" HIGH CUBE CONTAINER

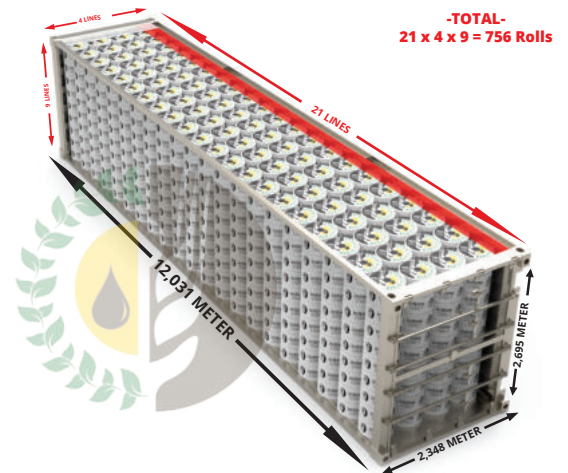
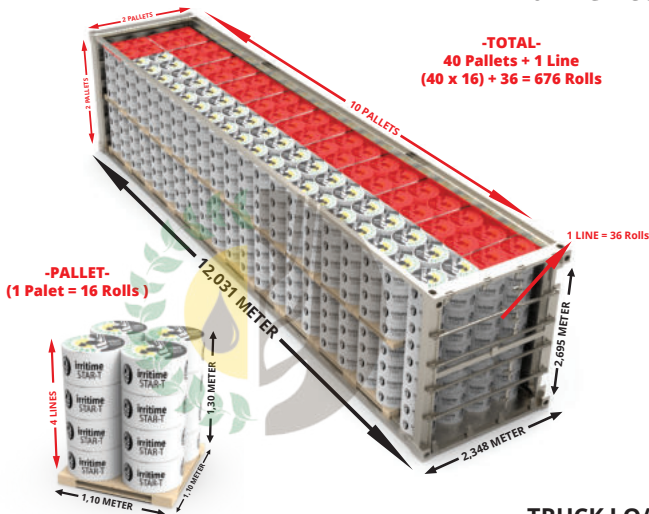

TRUCK LOADING PROGRAM

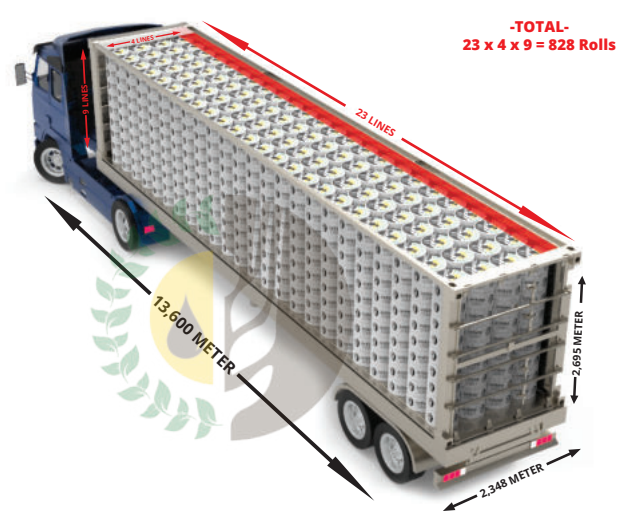
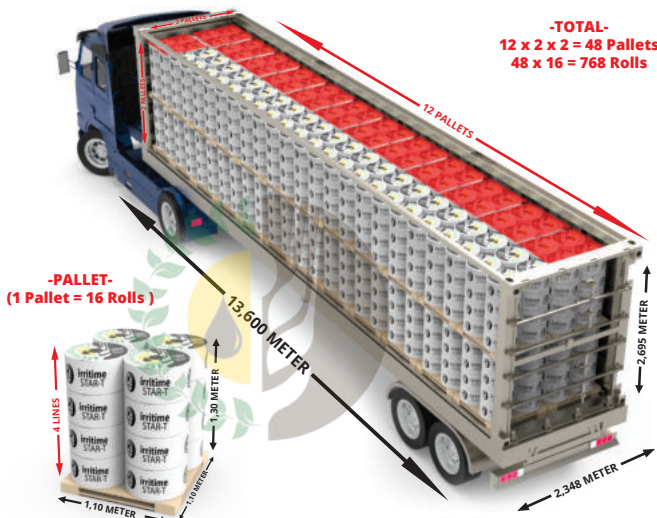

STAR-L
**6 ATÜ ALÇAK YOĞUNLUK UV KANGAL BORU
6 BARS LDPE UV COIL PIPES**

Kod Code	Çap Diameter Ø	BAR Maximum Recommended Pressure	Rulo Uzunluğu Roll Length
IR-LPE 25-6	25 mm	6 BARS (ATÜ)	200 meters
IR-LPE 32-6	32 mm		200 meters
IR-LPE 40-6	40 mm		100 meters
IR-LPE 50-6	50 mm		100 meters
IR-LPE 63-6	63 mm		100 meters
IR-LPE 75-6	75 mm		100 meters
IR-LPE 90-6	90 mm		100 meters

**10 ATÜ ALÇAK YOĞUNLUK UV KANGAL BORU
10 BARS LDPE UV COIL PIPES**

Kod Code	Çap Diameter Ø	BAR Maximum Recommended Pressure	Rulo Uzunluğu Roll Length
IR-LPE 25-10	25 mm	10 BARS (ATÜ)	200 meters
IR-LPE 32-10	32 mm		200 meters
IR-LPE 40-10	40 mm		100 meters
IR-LPE 50-10	50 mm		100 meters
IR-LPE 63-10	63 mm		100 meters
IR-LPE 75-10	75 mm		100 meters
IR-LPE 90-10	90 mm		100 meters
IR-LPE 110-10	110 mm		50 meters

**16 ATÜ ALÇAK YOĞUNLUK UV KANGAL BORU
16 BARS LDPE UV COIL PIPES**

Kod Code	Çap Diameter Ø	BAR Maximum Recommended Pressure	Rulo Uzunluğu Roll Length
IR-LPE 32-16	32 mm	16 BARS (ATÜ)	100 meters
IR-LPE 40-16	40 mm		100 meters
IR-LPE 50-16	50 mm		100 meters
IR-LPE 63-16	63 mm		100 meters
IR-LPE 75-16	75 mm		100 meters
IR-LPE 90-16	90 mm		100 meters
IR-LPE 110-16	110 mm		50 meters

DAMLAMA EK PARÇALARI **DRIP IRRIGATION FITTINGS**

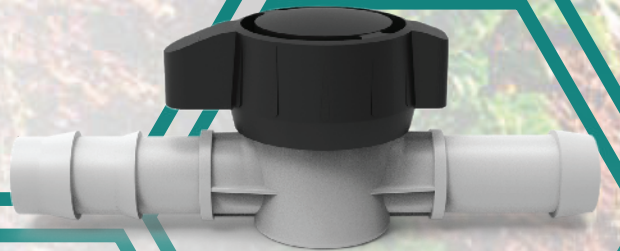
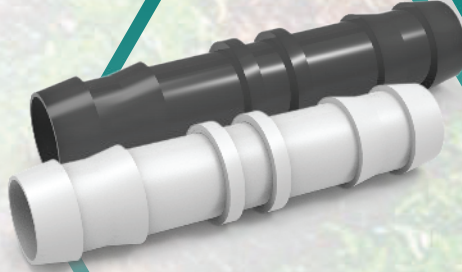



SİYAH SERİ KURTAĞZI EK PARÇALAR BLACK SERIES BARBED FITTINGS



Kod Code	Kurtağzı Nipel Barbed Nipple	Paketleme-Koli Packaging-Box
IR-BKN-1313	13X13mm	1.350
IR-BKN-1616	16X16mm	1.050
IR-BKN-2020	20X20mm	600
IR-BKN-2525	25X25mm	375
IR-BKN-3232	32X32mm	150



Kod Code	Kurtağzı Conta Çıkış Nipeli Barbed Start Nipple	Paketleme-Koli Packaging-Box
IR-BKCN-1616	16X16mm	1.350
IR-BKCN-2020	20X20mm	900



Kod Code	Kurtağzı Te Barbed Tee	Paketleme-Koli Packaging-Box
IR-BKT-1313	13X13X13mm	900
IR-BKT-1616	16X16X16mm	750
IR-BKT-2016	20X16X20mm	450
IR-BKT-2020	20X20X20mm	450
IR-BKT-2516	25X16X25mm	225
IR-BKT-2520	25X20X25mm	225
IR-BKT-2525	25X25X25mm	225



Kod Code	Kurtağzı Dirsek Barbed Elbow	Paketleme-Koli Packaging-Box
IR-BKD-1616	16X16mm	1.050
IR-BKD-2020	20X20mm	750



Kod Code	Gözlük Körtapa 8 Type End Cap	Paketleme-Koli Packaging-Box
IR-BGKT-16	16 mm	1.500
IR-BGKT-20	20 mm	900
IR-BGKT-25	25 mm	600
IR-BGKT-32	32 mm	300

Connection Guide



STAR-R Yuvarlak borular için ,
Bağlantı uyumluluğu vardır .

Suitable connection with ;
STAR-R Round Drip Pipes

16 mm - 20 mm - 25 mm - 32 mm



GRİ SERİ KURTAĞZI EK PARÇALAR GREY SERIES BARBED FITTINGS

Damla Sulama Ek Parçaları
Drip Irrigation Fittings



Kod Code	Kurtağzı Nipel Barbed Nipple	Paketleme-Koli Packaging-Box
IR-KN-1313	13X13mm	1.500
IR-KN-1616	16X16mm	1.050
IR-KN-2020	20X20mm	600
IR-KN-2525	25X25mm	375
IR-KN-3232	32X32mm	150



Kod Code	Kurtağzı Conta Çıkış Nipel Barbed Start Nipple	Paketleme-Koli Packaging-Box
IR-KCN-1616	16X16mm	1.350
IR-KCN-1620	20X20mm	900



Kod Code	Kurtağzı Te Barbed Tee	Paketleme-Koli Packaging-Box
IR-KT-1313	13X13X13mm	900
IR-KT-1616	16X16X16mm	750
IR-KT-2016	20X16X20mm	450
IR-KT-2020	20X20X20mm	450
IR-KT-2516	25X16X25mm	225
IR-KT-2520	25X20X25mm	225
IR-KT-2525	25X25X25mm	225



Kod Code	Kurtağzı Dirsek Barbed Elbow	Paketleme-Koli Packaging-Box
IR-KD-1616	16X16mm	1.050
IR-KD-2020	20X20mm	750

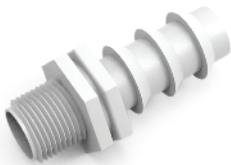

Kod Code	Kurtağzı Erkek Nipel Barbed Male Nipple	Paketleme-Koli Packaging-Box
IR-KEN-161/2	16 x 1/2"	900
IR-KEN-163/4	16 x 3/4"	900



Kod Code	Gözlük Körtapa 8 Type End Cap	Paketleme-Koli Packaging-Box
IR-GKT-16	16 mm	1.500



Kod Code	Konik Conta Conical Start O-Ring	Paketleme-Koli Packaging-Box
IR-KC-16	16 mm	2.250
IR-KC-20	20 mm	1.650



Kod Code	Düz Conta Straight O-Ring	Paketleme-Koli Packaging-Box
IR-KDC-16	16 mm	1.950
IR-KDC-20	20 mm	1.650



Kod Code	Pe Erkek Dişli Nipel Pe Male Nipple	Paketleme-Koli Packaging-Box
IR-13511	½" X ½"	900
IR-13522	¾" X ¾"	900
IR-13533	1" X 1"	750



Kod Code	Kurtağzı Erkek Nipel Barbed Male Nipple	Paketleme-Koli Packaging-Box
IR-BKEN-161/2	16 x ½"	900
IR-BKEN-163/4	16 x ¾"	900
IR-BKEN-201/2	20 x ½"	750
IR-BKEN-203/4	20 x ¾"	750
IR-BKEN-253/4	25 x ¾"	375
IR-BKEN-251	25 x 1"	300
IR-BKEN-321	32 x 1"	150



Kod Code	Kurtağzı Erkek Te Barbed Male Tee	Paketleme-Koli Packaging-Box
IR-KET-161/2	16 x ½" x 16	750
IR-KET-163/4	16 x ¾" x 16	675
IR-KET-201/2	20 x ½" x 20	450
IR-KET-203/4	20 x ¾" x 20	450
IR-KET-201	20 x 1" x 20	450



Kod Code	Kurtağzı Erkek Dirsek Barbed Male Elbow	Paketleme-Koli Packaging-Box
IR-KED-161/2	16 x ½"	900
IR-KED-163/4	16 x ¾"	750
IR-KED-201/2	20 x ½"	750
IR-KED-203/4	20 x ¾"	750



Kod Code	Kurtağzı Kör Tapa Barbed End Cap	Paketleme-Koli Packaging-Box
IR-KKT-16	16mm	1.500
IR-KKT-20	20mm	900



SOMUNLU EK PARÇALAR LOCKED FITTINGS

Damla Sulama Ek Parçaları
Drip Irrigation Fittings



Kod Code	Somunlu Nipel Locked Nipple	Paketleme-Koli Packaging-Box	Connection Bağlantı
IR-SEN-1717	17X17mm	450	Yuvarlak / Yassı Round / T-Tape
IR-SEN-2222	22X22mm	300	Yuvarlak / Yassı Round / T-Tape
IR-SEN-2525	25X25mm	300	Yuvarlak Round



Kod Code	Kurtağzı Conta Çıkış & Somunlu Nipel Nipple Barbed Start & Locked	Paketleme-Koli Packaging-Box	Connection Bağlantı
IR-KCSEN-1716	17X16mm	600	Yuvarlak / Yassı Round / T-Tape
IR-KCSEN-2220	22X20mm	375	Yuvarlak / Yassı Round / T-Tape
IR-KCSEN-2520	25X20mm	375	Yuvarlak Round



Kod Code	Kurtağzı & Somunlu Nipel Nipple Barbed & Locked	Paketleme-Koli Packaging-Box	Connection Bağlantı
IR-KSEN-1716	17X16mm	600	Yuvarlak / Yassı Round / T-Tape



Kod Code	Somunlu Kör Tapa Locked End Cap	Paketleme-Koli Packaging-Box	Connection Bağlantı
IR-SKT-17	17mm	750	Yuvarlak / Yassı Round / T-Tape
IR-SKT-22	22mm	450	Yuvarlak / Yassı Round / T-Tape

Connection Guide



STAR-R Yuvarlak borular için ,
Bağlantı uyumluluğu vardır .

Suitable connection with ;
STAR-R Round Drip Pipes

16 mm - 20 mm - 25 mm



STAR T Yassı borular için ,
Bağlantı uyumluluğu vardır .

Suitable connection with ;
STAR T T-Tape Drip Pipes

17 mm - 22 mm



YÜZÜKLÜ EK PARÇALAR PRESSED FITTINGS

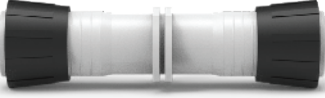

Kod Code	Yüzüklü Nipel Nipple Pressed	Paketleme-Koli Packaging-Box
IR-YEN-1717	17X17mm	750
IR-YEN-2222	22X22mm	375
IR-YEN-2525	25x25mm	225

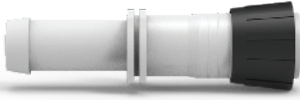

Kod Code	Kurtagzı Conta Çıkış & Yüzüklü Nipel Nipple Barbed Start & Pressed	Paketleme-Koli Packaging-Box
IR-KCYEN-1716	17X16mm	900
IR-KCYEN-2220	22X20mm	375
IR-KCYEN-2520	25x20mm	225

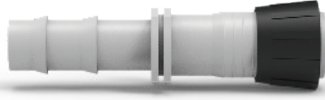

Kod Code	Kurtagzı & Yüzüklü Nipel Nipple Barbed & Pressed	Paketleme-Koli Packaging-Box
IR-KYEN-1716	17X16mm	900



Kod Code	Yüzüklü Kör Tapa Pressed End Cap	Paketleme-Koli Packaging-Box
IR-YKT-17	17mm	900
IR-YKT-22	22mm	450

Connection Guide



STAR T Yassı borular için ,
Bağlantı uyumluluğu vardır .

Suitable connection with ;
STAR T T-Tape Drip Pipes

17 mm - 22 mm - 25 mm



MİNİ VANALAR MINI VALVES

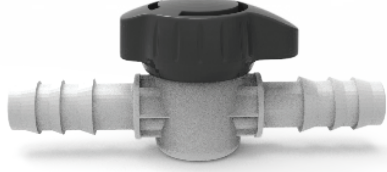

Kod Code	Kurtağı Mini Vana Mini Valve Barbed	Paketleme-Koli Packaging-Box
IR-KMV-1616	16X16mm	240
IR-KMV-2016	16X20mm	210
IR-KMV-2020	20X20mm	210
IR-KMV-2525	25X25mm	150

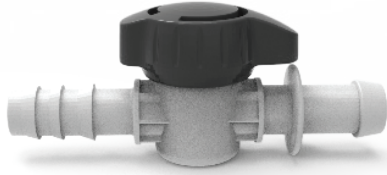

Kod Code	Kurtağı & Conta Çıkış Mini Vana Mini Valve Barbed Start & Barbed	Paketleme-Koli Packaging-Box
IR-KCMV-1616	16X16mm	240
IR-KCMV-2020	20X20mm	210
IR-KCMV-2520	25X20mm	180

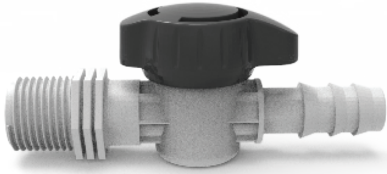

Kod Code	Dişli & Kurtağı Mini Vana Mini Valve Male & Barbed	Paketleme-Koli Packaging-Box
IR-KDMV-1/216	½" X 16mm	240
IR-KDMV-1/220	½" X 20mm	180
IR-KDMV-3/416	¾" X 16mm	225
IR-KDMV-3/420	¾" X 20mm	180

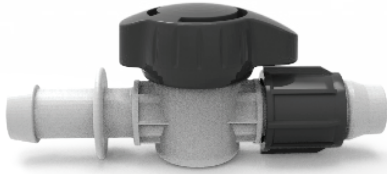

Kod Code	Kurt Ağı Çıkış & Somunlu Mini Vana Mini Valve Barbed Start & Locked	Paketleme-Koli Packaging-Box
IR-KCSMV-1617	16X17mm	180
IR-KCSMV-2022	22X20mm	150
IR-KCSMV-2025	25X20mm	150

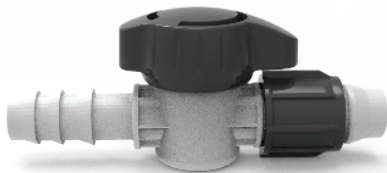

Kod Code	Kurt Ağı & Somunlu Mini Vana Mini Valve Barbed & Locked	Paketleme-Koli Packaging-Box
IR-KSMV-1617	16X17mm	225
IR-KSMV-2022	22X20mm	150
IR-KSMV-2025	25X20mm	150

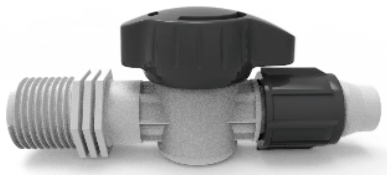

Kod Code	Dişli & Somunlu Mini Vana Mini Valve Male & Locked	Paketleme-Koli Packaging-Box
IR-SDMV-1/217	½" X 17mm	240
IR-SDMV-1/222	½" X 22mm	180
IR-SDMV-1/225	½" X 25mm	180
IR-SDMV-3/417	¾" X 17mm	240
IR-SDMV-3/422	¾" X 22mm	180
IR-SDMV-3/425	¾" X 25mm	180



Kod Code	Somunlu Mini Vana Mini Valve Locked For Tape	Paketleme-Koli Packaging-Box
IR-SMV-1717	17X17mm	225
IR-SMV-2222	22X22mm	150
IR-SMV-2525	25X25mm	150

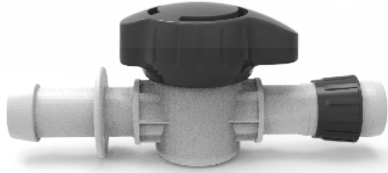

Kod Code	Kurt Ağızı Conta Çıkış & Yüzüklü Mini Vana Mini Valve Barbed Start & Pressed	Paketleme-Koli Packaging-Box
IR-KCYMV-1617	16X17mm	240
IR-KCYMV-2220	20X22mm	150

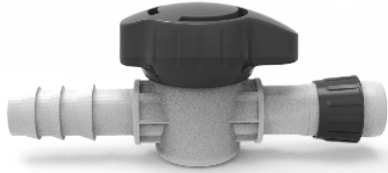

Kod Code	Kurt Ağızı & Yüzüklü Mini Vana Mini Valve Barbed & Pressed	Paketleme-Koli Packaging-Box
IR-KYMV-1617	16X17mm	240
IR-KYMV-2220	20X22mm	150

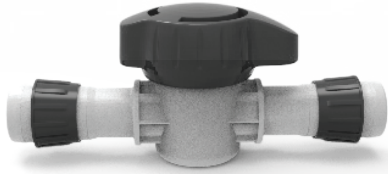

Kod Code	Yüzüklü Mini Vana Mini Valve Pressed For Tape	Paketleme-Koli Packaging-Box
IR-YMV-1717	17X17mm	240
IR-YMV-2222	22X22mm	210

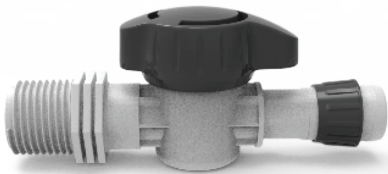

Kod Code	Dişli & Yüzüklü Mini Vana Mini Valve Male & Pressed	Paketleme-Koli Packaging-Box
IR-YDMV-1/217	½" X 17mm	240
IR-YDMV-1/222	½" X 22mm	180
IR-YDMV-3/417	¾" X 17mm	225
IR-YDMV-3/422	¾" X 22mm	180

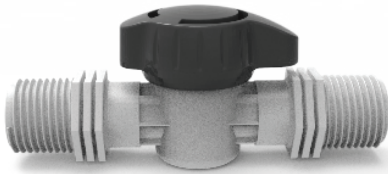

Kod Code	Dişli Mini Vana Mini Valve Male	Paketleme-Koli Packaging-Box
IR-DDMV-1/2	½" X ½"	270
IR-DDMV-3/4	¾" X ¾"	210
IR-DDMV-1/2-3/4	½" X ¾"	210

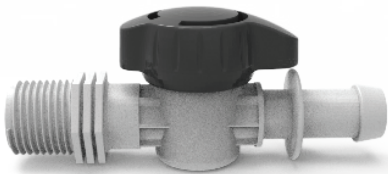

Kod Code	Kurtağızı Çıkış & Dişli Mini Vana Mini Valve Male & Barbed Start	Paketleme-Koli Packaging-Box
IR-KCDMV-1/216	½" X 16mm	240
IR-KCDMV-3/416	¾" X 16mm	225

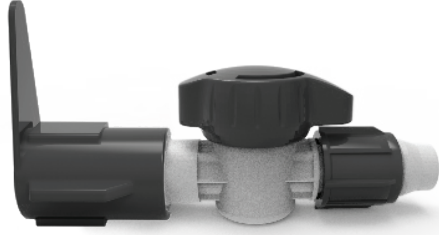

Kod Code	Layflat Dış Dişli & Somunlu Mini Vana Mini Valve Male Layflat & Locked	Paketleme-Koli Packaging-Box
IR-LSDMV-1/217	½" X 17mm	200
IR-LSDMV-1/222	½" X 22mm	180
IR-LSDMV-1/225	½" X 25mm	90
IR-LSDMV-3/417	¾" X 17mm	200
IR-LSDMV-3/422	¾" X 22mm	180
IR-LSDMV-3/425	¾" X 25mm	90

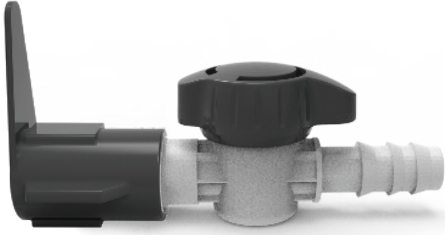

Kod Code	Layflat Dış Dişli & Kurtağı Mini Vana Mini Valve Male Layflat & Barbed	Paketleme-Koli Packaging-Box
IR-LKDMV-1/216	½" X 16mm	200
IR-LKDMV-1/220	½" X 20mm	180
IR-LKDMV-3/416	¾" X 16mm	200
IR-LKDMV-3/420	¾" X 20mm	180

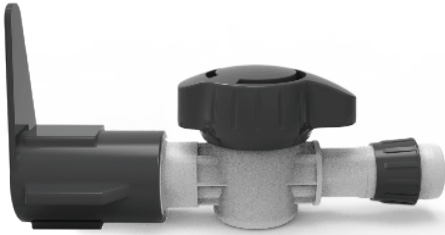

Kod Code	Layflat Dış Dişli & Yüzüklü Mini Vana Mini Valve Male Layflat & Pressed	Paketleme-Koli Packaging-Box
IR-LYDMV-1/217	½" X 17mm	180
IR-LYDMV-1/222	½" X 22mm	135
IR-LYDMV-3/417	¾" X 17mm	180
IR-LYDMV-3/422	¾" X 22mm	135

Connection Guide



STAR-R Yuvarlak borular için ,
Bağlantı uyumluluğu vardır .

Suitable connection with ;
STAR-R Round Drip Pipes

16 mm - 20 mm - 25 mm



STAR T Yassı borular için ,
Bağlantı uyumluluğu vardır .

Suitable connection with ;
STAR T T-Tape Drip Pipes

17 mm - 22 mm



STAR-R Yuvarlak borular için ,
Bağlantı uyumluluğu vardır .

Suitable connection with ;
STAR-R Round Drip Pipes

16 mm - 20 mm



STAR T Yassı borular için ,
Bağlantı uyumluluğu vardır .

Suitable connection with ;
STAR T T-Tape Drip Pipes

17 mm - 22 mm



HAT ÜSTÜ DAMLATICILAR ONLINE DRIPPERS



Damla Sulama Ek Parçaları
Drip Irrigation Fittings



Kod Code	Bayrak Hat Üstü Damlatıcı Flag Online Dripper	Paketleme-Koli Packaging-Box
IR-OTD-8	8 Lt/h-Lt/sa	4.000



Kod Code	Debi Ayarlı Hat Üstü Damlatıcı Adjustable Online Dripper	Paketleme-Koli Packaging-Box
HAT-70	0-70 lph	4.200

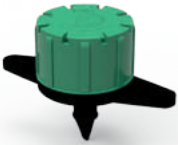

Kod Code	Debi Ayarlı Hat Üstü Damlatıcı Adjustable Online Dripper	Paketleme-Koli Packaging-Box
HAT-100	0-100 lph	1.500



Kod Code	Debi Ayarlı Hat Üstü Damlatıcı Adjustable Online Dripper	Paketleme-Koli Packaging-Box
HAT-140	0-140 lph	1.000



Kod Code	Körtapa End Cap	Paketleme-Koli Packaging-Box
IR-0179	4 mm	2.000



Kod Code	ELF PC Hat Üstü Damlatıcı ELF Online PC Dripper	Renk Color	Paketleme-Koli Packaging-Box
IR-OPD-2	2 Lt/h-Lt/sa	Blue - Mavi	1.500
IR-OPD-3	3 Lt/h-Lt/sa	Grey - Gri	1.500
IR-OPD-4	4 Lt/h-Lt/sa	Green - Yeşil	1.500
IR-OPD-6	6 Lt/h-Lt/sa	Black - Siyah	1.500
IR-OPD-8	8 Lt/h-Lt/sa	Brown - Kahverengi	1.500
IR-OPD-12	12 Lt/h-Lt/sa	Red - Kırmızı	1.500
IR-OPD-16	16 Lt/h-Lt/sa	Purple - Mor	1.500

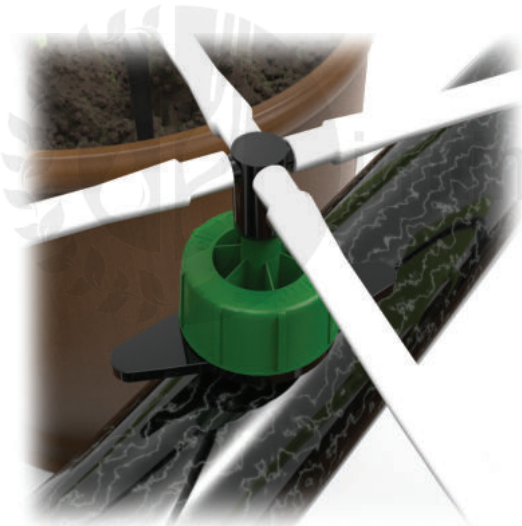



SAKSI SULAMA SETİ ARROW SET

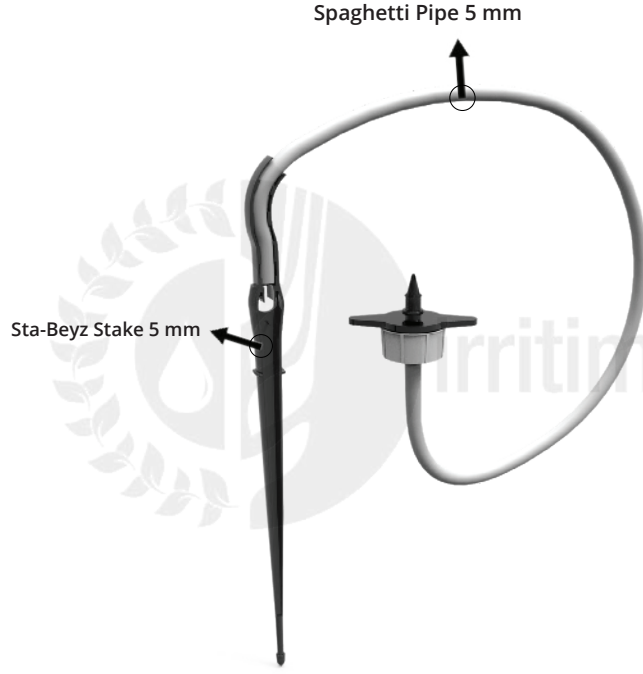

Tekli Saksi Sulama Seti Single Arrow Set

Kod Code	Boru Uzunluğu Length of Pipe	Kazık Tipi Arrow Type	Boru Tipi Tube Type	Boru Rengi Tube Color
IR-SAB40-2	40 cm Tube	Sta-Beyz	3x5 mm	Black
IR-SAB50-2	50 cm Tube	Sta-Beyz	3x5 mm	Black
IR-SAB60-2	60 cm Tube	Sta-Beyz	3x5 mm	Black
IR-SAB70-2	70 cm Tube	Sta-Beyz	3x5 mm	Black
IR-SAB80-2	80 cm Tube	Sta-Beyz	3x5 mm	Black
IR-SAW40-2	40 cm Tube	Sta-Beyz	3x5 mm	White
IR-SAW50-2	50 cm Tube	Sta-Beyz	3x5 mm	White
IR-SAW60-2	60 cm Tube	Sta-Beyz	3x5 mm	White
IR-SAW70-2	70 cm Tube	Sta-Beyz	3x5 mm	White
IR-SAW80-2	80 cm Tube	Sta-Beyz	3x5 mm	White



Beyz

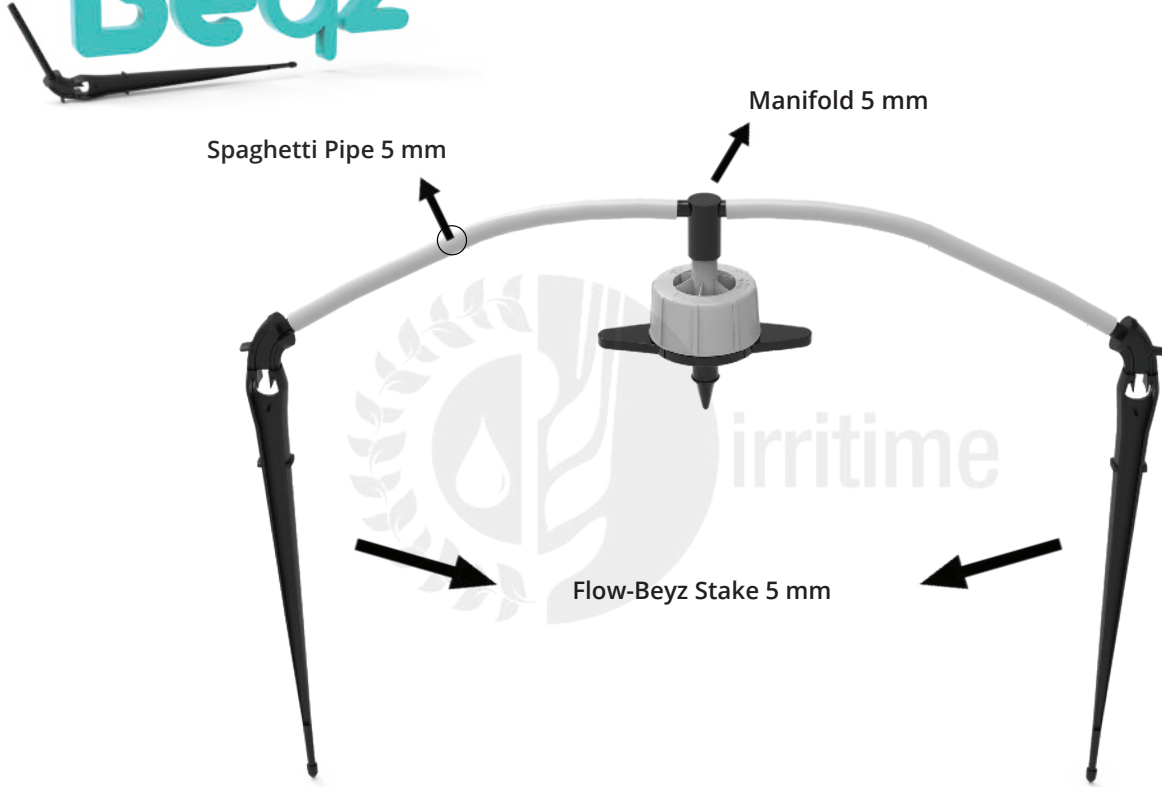

Damla Sulama Ek Parçaları
Drip Irrigation Fittings

İkili Saksı Sulama Seti Double Arrow Set

Kod Code	Boru Uzunluğu Length of Pipe	Kazık Tipi Arrow Type	Boru Tipi Tube Type	Boru Rengi Tube Color
IR-DAB40-2	40 cm Tube	Flow-Beyz	3x5 mm	Black
IR-DAB50-2	50 cm Tube	Flow-Beyz	3x5 mm	Black
IR-DAB60-2	60 cm Tube	Flow-Beyz	3x5 mm	Black
IR-DAB70-2	70 cm Tube	Flow-Beyz	3x5 mm	Black
IR-DAB80-2	80 cm Tube	Flow-Beyz	3x5 mm	Black
IR-DAW40-2	40 cm Tube	Flow-Beyz	3x5 mm	White
IR-DAW50-2	50 cm Tube	Flow-Beyz	3x5 mm	White
IR-DAW60-2	60 cm Tube	Flow-Beyz	3x5 mm	White
IR-DAW70-2	70 cm Tube	Flow-Beyz	3x5 mm	White
IR-DAW80-2	80 cm Tube	Flow-Beyz	3x5 mm	White



Spaghetti Pipe 5 mm

Manifold 5 mm

Beuz



Damla Sulama Ek Parçaları
Drip Irrigation Fittings

Dörtlü Sakı Sulama Seti Quarted Arrow Set

Kod Code	Boru Uzunluğu Length of Pipe	Kazık Tipi Arrow Type	Boru Tipi Tube Type	Boru Rengi Tube Color
IR-QAB40-2	40 cm Tube	Flow-Beyz	3x5 mm	Black
IR-QAB50-2	50 cm Tube	Flow-Beyz	3x5 mm	Black
IR-QAB60-2	60 cm Tube	Flow-Beyz	3x5 mm	Black
IR-QAB70-2	70 cm Tube	Flow-Beyz	3x5 mm	Black
IR-QAB80-2	80 cm Tube	Flow-Beyz	3x5 mm	Black
IR-QAW40-2	40 cm Tube	Flow-Beyz	3x5 mm	White
IR-QAW50-2	50 cm Tube	Flow-Beyz	3x5 mm	White
IR-QAW60-2	60 cm Tube	Flow-Beyz	3x5 mm	White
IR-QAW70-2	70 cm Tube	Flow-Beyz	3x5 mm	White
IR-QAW80-2	80 cm Tube	Flow-Beyz	3x5 mm	White



Sta-Beyz

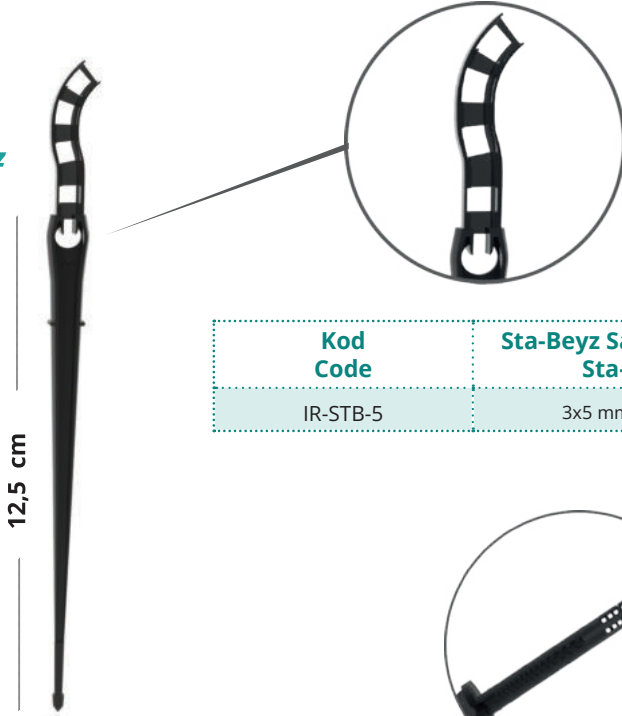

12,5 cm

Kod Code	Sta-Beyz Saksı Sulama Kazığı Sta-Beyz Stake	Paketleme-Koli Packaging-Box
IR-STB-5	3x5 mm - Diameter Tube	1.500



Flow-Beyz

Kod Code	Flow-Beyz Saksı Sulama Kazığı Flow-Beyz Arrow Dripper	Paketleme-Koli Packaging-Box
IR-FLB-15	3x5 mm - Diameter Tube Flow Rate 1,5 lt/h	1.500
IR-FLB-20	3x5 mm - Diameter Tube Flow Rate 2,0 lt/h	1.500

12,5 cm

Dia-Beyz

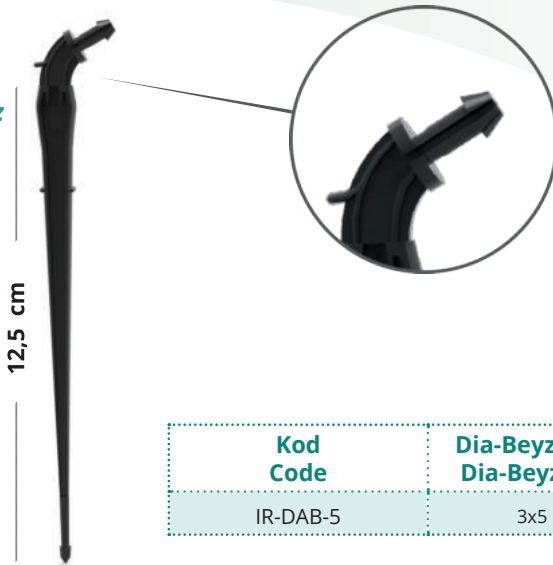

12,5 cm

Kod Code	Dia-Beyz Saksı Sulama Kazığı Dia-Beyz 30° Diagonal Stake	Paketleme-Koli Packaging-Box
IR-DAB-5	3x5 mm - Diameter Tube	1.500



Damla Sulama Ek Parçaları
Drip Irrigation Fittings

Kod Code	Boru Sabitleme Kazığı Pipe Stabiliser	Paketleme-Koli Packaging-Box
IR-PSS-16	16 mm - Short - Kısa	375

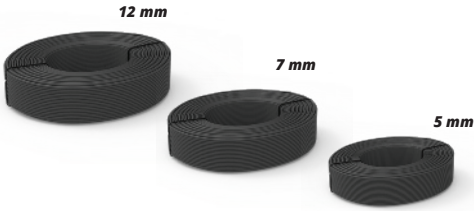

Kod Code	Pvc Spagetti Boru Spaghetti Pipe	Paketleme-Koli Packaging-Box
IR-407-5	5 mm	250 mt
IR-407-7	7 mm	200 mt
IR-407-12	12 mm	200 mt



Kod Code	5 mm Dağıtıcı 5 mm Manifold	Paketleme-Koli Packaging-Box
IR-425	2'li-Dual	2.000
IR-426	4'lü-Quadruplet	2.000



Kod Code	5 mm Vidalı Start Çıkış 5 mm Start Adaptor	Paketleme-Koli Packaging-Box
IR-223	Tek Taraflı - Single Sided	5.000
IR-224	Çift Taraflı - Double Sided	5.000

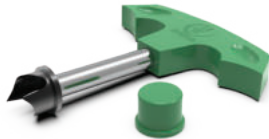

Kod Code	Delme Aparatı Manual Punch	Paketleme-Koli Packaging-Box
IR-DELA-16	16 mm	200
IR-DELA-20	20 mm	200



Kod Code	Delme Aparatı Manual Punch	Paketleme-Koli Packaging-Box
IR-DELA-03	3 mm	200



DAMLA SULAMA EK PARÇALARI DRIP IRRIGATION FITTINGS



Damla Sulama Ek Parçaları
Drip Irrigation Fittings



Kod Code	Matkap Ucu Delme Aparatı Drill Punch	Paketleme-Koli Packaging-Box
IR-DELAM-16	16 mm - Drill	500
IR-DELAM-20	20 mm - Drill	400



Kod Code	Çift Etkili Hava Vantuzu Double - Acting Air Release Valve	Paketleme-Koli Packaging-Box
IR-DAV-1	1"	36



Kod Code	Tek Etkili Hava Vantuzu Single - Acting Air Release Valve	Paketleme-Koli Packaging-Box
IR-SAV-3/4	3/4"	40
IR-SAV-1	1"	36



Kod Code	Kinetik Hava Vantuzu Kinetic Air Release Valve	Paketleme-Koli Packaging-Box
IR-KAV-2	2"	10



Kod Code	Boru Askısı Pipe Hanging Hook	Paketleme-Koli Packaging-Box
IR-PHH-16	16 mm	2.000
IR-PHH-22	22 mm	1.500



Kod Code	Boru Sıkma Kelepçesi Offtake Clamp	Paketleme-Koli Packaging-Box
IR-OC-16	16 mm	2.000
IR-OC-20	20 mm	1.500



Kod Code	Sera Klipi Greenhouse Clip	Paketleme-Koli Packaging-Box
IR-GC-22	22 mm	1.000
IR-GC-27	27 mm	1.000
IR-GC-32	32 mm	1.000

MIKRO YAĞMURLAMA **MICRO SPRINKLER**

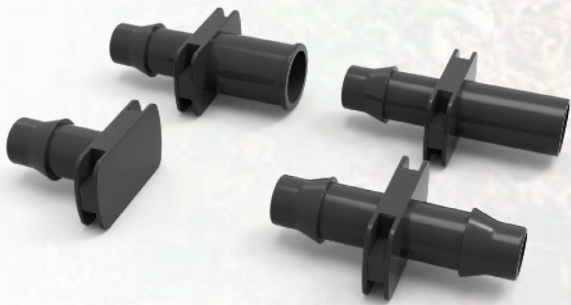

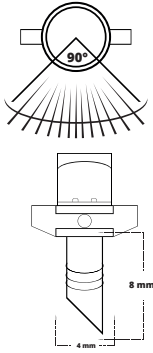

90° Radius Stable Mini Sprink

Kod Code	Özellik Property	Paketleme-Koli Packaging-Box
IR-406-90	90° - Yeşil-Green - 120 lt./h	20.000

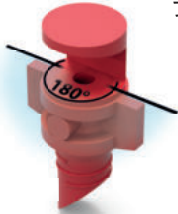
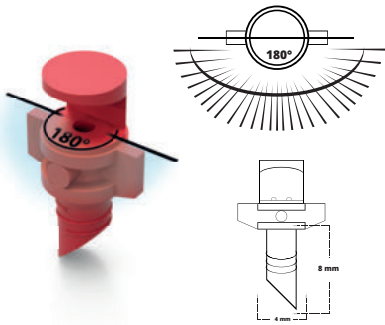

180° Radius Stable Mini Sprink

Kod Code	Özellik Property	Paketleme-Koli Packaging-Box
IR-406-180	180° - Kırmızı-Red - 120 lt./h	20.000

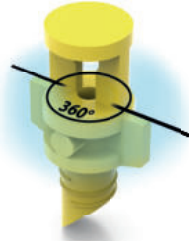
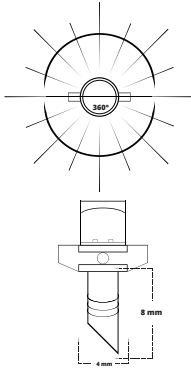

360° Radius Stable Mini Sprink

Kod Code	Özellik Property	Paketleme-Koli Packaging-Box
IR-406-360	360° - Sarı-Yellow - 120 lt./h	20.000



Radius Stable Sprayer Set

Kod Code	Özellik Property	Paketleme-Koli Packaging-Box
IR-406-90S	90° - Yeşil-Green - 120 lt./h	1.500
IR-406-180S	180° - Kırmızı-Red - 120 lt./h	1.500
IR-406-360S	360° - Sarı-Yellow - 120 lt./h	1.500
IR-406-R	Riser 20 cm Length	1.500



Kod Code	Kazıklı Mini Sprink Seti Rotating Sprayer Set	Paketleme-Koli Packaging-Box
IR-400-80	Yeşil-Green : 80 lt.	100
IR-400-120	Kırmızı-Red : 120 lt.	100
IR-400-160	Sarı-Yellow : 160 lt.	100



Kod Code	Mini Sprink Rotating Sprayer	Paketleme-Koli Packaging-Box
IR-402-80	Yeşil-Green : 80 lt.	1.000
IR-402-120	Kırmızı-Red : 120 lt.	1.000
IR-402-160	Sarı-Yellow : 160 lt.	1.000

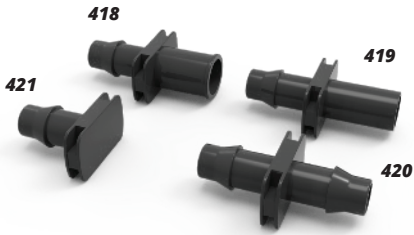

Kod Code	7 mm Nozul Adaptör Nipple Adaptor	Paketleme-Koli Packaging-Box
IR-418	Dişi Adaptör - Female Adaptor	5.000
IR-419	Erkek Adaptör - Male Adaptor	5.000
IR-420	Ekleme - Adding	5.000
IR-421	Kör Tapa - End Cap	5.000



Kod Code	Mini Sprink Kazığı Sprayer Stake	Paketleme-Koli Packaging-Box
IR-403	40 cm	100

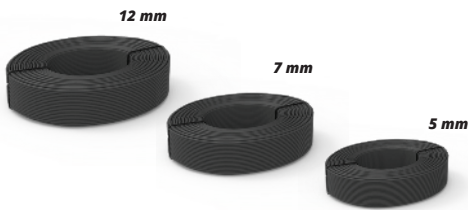

Kod Code	Pvc Spagetti Boru Spaghetti Pipe	Paketleme-Koli Packaging-Box
IR-407-5	5 mm	250 mt
IR-407-7	7 mm	200 mt
IR-407-12	12 mm	200 mt

BOX LOADING PROGRAM

WITH PALLET

20" DC CONTAINER

WITHOUT PALLET

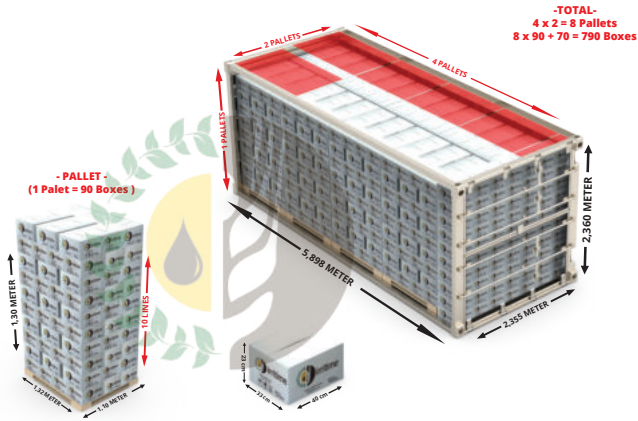

40" HIGH CUBE CONTAINER

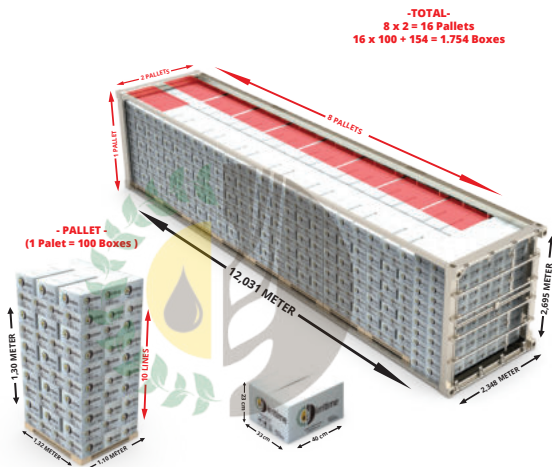

TRUCK LOADING PROGRAM

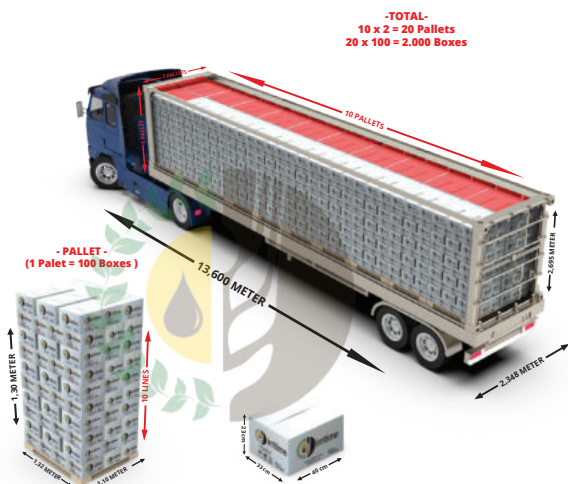



FİLTRE SİSTEMLERİ **FILTER SYSTEMS**





Maks. Çalışma Basıncı
Max. Working Pressure

8 Bars
(116 PSI)

Filtrasyon Derecesi
Filtration Degree

20-50-100-125 Micron

Plastik Filtreler | Plastic Filters (Helix Systems)

Ebat Size	Tip Type	Kod Code	Filtrasyon Tipi Filtration Type	Debi Flow Rate m ³ /h	Ağırlık Weight kg
2"	SHORT	IR-PMD2	Disc - Disk	20	6
2"	NORMAL	IR-PD2	Disc - Disk	33	7
2"	SUPER	IR-PSD2	Disc - Disk	35	8
2½"	NORMAL	IR-PD25	Disc - Disk	35	7,1
2½"	SUPER	IR-PSD25	Disc - Disk	40	8,1
3"	NORMAL	IR-PD3	Disc - Disk	45	7,2
3"	SUPER	IR-PSD3	Disc - Disk	50	8,2
2"	SHORT	IR-PME2	Mesh - Elek	20	5,2
2"	NORMAL	IR-PE2	Mesh - Elek	30	5,4
2"	SUPER	IR-PSE2	Mesh - Elek	35	6,3
2½"	NORMAL	IR-PE25	Mesh - Elek	35	5,5
2½"	SUPER	R-PSE25	Mesh - Elek	40	6,4
3"	NORMAL	IR-PE3	Mesh - Elek	45	5,6
3"	SUPER	IR-PSE3	Mesh - Elek	50	6,5

Maks. Çalışma Basıncı
Max. Working Pressure

8 Bars
(116 PSI)

Filtrasyon Derecesi
Filtration Degree

20-50-100-125 Micron

Plastik İkiz Filtreler | Plastic Double Filters (Helix Systems)

Ebat Size	Tip Type	Kod Code	Filtrasyon Tipi Filtration Type	Debi Flow Rate m ³ /h	Ağırlık Weight kg
3"	NORMAL	IR-DD3	Disc - Disk	50	11,4
3"	SUPER	IR-DDS3	Disc - Disk	70	11,6
4"	NORMAL	IR-DD4	Disc - Disk	60	13,6
4"	SUPER	IR-DDS4	Disc - Disk	80	13,8
3"	NORMAL	IR-DE3	Mesh - Elek	50	8,4
3"	SUPER	IR-DES3	Mesh - Elek	70	8,6
4"	NORMAL	IR-DE4	Mesh - Elek	60	9,8
4"	SUPER	IR-DES4	Mesh - Elek	80	10,0

Plastik Filtre İç Takımları Plastic Filters Cartridge

Kod Code

Açıklama
Description

IR-17001

Short - Kısa

IR-17002

Normal - Normal

IR-17003

Super - Süper



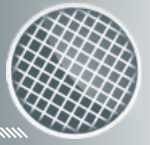

**Plastik Mini Filtre (Type Mini)
Plastic Mini Filter (Type Mini)**

Kod Code	Tip Type	Ebat Size	Filtrasyon Tipi Filtration Type	Debi Flow Rate m ³ /h	Ağırlık Weight kg	Paketleme Packaging
IR-MNPE3/4	MINI	¾"	Mesh - Elek	5	0,30	15
IR-MNPE10	MINI	1"	Mesh - Elek	6	0,30	15
IR-MNPD3/4	MINI	¾"	Disc - Disk	5	0,45	15
IR-MNPD10	MINI	1"	Disc - Disk	6	0,45	15



**Plastik Mini Filtre (Type Midi)
Plastic Mini Filter (Type Midi)**

Kod Code	Tip Type	Ebat Size	Filtrasyon Tipi Filtration Type	Debi Flow Rate m ³ /h	Ağırlık Weight kg	Paketleme Packaging
IR-MDPE10	MIDI	1"	Mesh - Elek	6	0,30	4
IR-MDPE15	MIDI	1½"	Mesh - Elek	15	0,75	4
IR-MDPD10	MIDI	1"	Disc - Disk	6	0,45	4
IR-MDPD15	MIDI	1½"	Disc - Disk	15	1,00	4



**Plastik Mini Filtre (Type Maxi)
Plastic Mini Filter (Type Maxi)**

Kod Code	Tip Type	Ebat Size	Filtrasyon Tipi Filtration Type	Debi Flow Rate m ³ /h	Ağırlık Weight kg	Paketleme Packaging
IR-MXPE15	MAXI	1½"	Mesh - Elek	15	0,75	2
IR-MXPE20	MAXI	2"	Mesh - Elek	25	1,20	2
IR-MXPD15	MAXI	1½"	Disc - Disk	15	1,00	2
IR-MXPD20	MAXI	2"	Disc - Disk	25	1,50	2

**Disk Kartuş
Disc Cartridge**

**Elek Kartuş
Mesh Cartridge**

**Mini Plastik Filtre İç Takımları
Mini Plastic Filters Cartridge**

Kod Code	Tip Type	Filtrasyon Tipi Filtration Type	Paketleme Packaging
IR-17004	MINI	Disc - Disk	5
IR-17005	MINI	Mesh - Elek	5
IR-17006	MIDI	Disc - Disk	5
IR-17007	MIDI	Mesh - Elek	5
IR-17008	MAXI	Disc - Disk	5
IR-17009	MAXI	Mesh - Elek	5



Plastik Hidrosiklon Plastic Hydrocyclone

Kod Code	Tip Type	Ebat Size	Açıklama Description
IR-P2020	Normal	2"	2" Plastic Hydrocyclone
IR-P2025	Normal	2½"	2½" Plastic Hydrocyclone
IR-P203006	Normal	3"	3" Plastic Hydrocyclone Drainage Tank 8 Lt
IR-P203010	Normal	3"	3" Plastic Hydrocyclone Drainage Tank 25 Lt



Plastik Gübre Tankı Plastic Fertilizer Tank

Kod Code	Ebat Size	Açıklama Description
IR-P1100	100 Lt	Normal
IR-P1200	200 Lt	Normal
IR-P1100M	100 Lt	With Membrane
IR-P1200M	200 Lt	With Membrane



Plastik Kum Filtresi Plastic Sand Media Filter

Kod Code	Ebat Size	Açıklama Description
IR-P3020	2"	Plastic Sand media filter (24")
IR-P3025	2½"	Sand media filter (24")
IR-P3030	3"	Sand media filter (24")

Filtre Sistemleri
Filter System

BAĞLANTI TİPLERİ CONNECTION TYPES

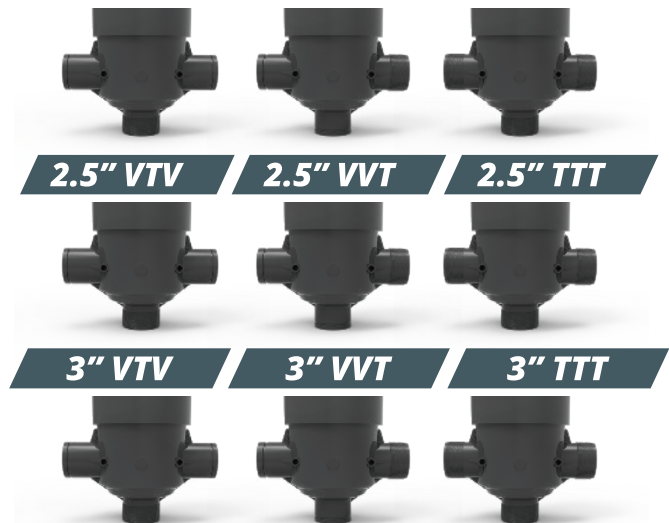

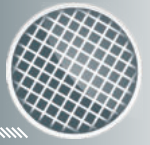

Dikey Metal Filtreler Vertical Metal Filter

Kod Code	Ebat Size	Çap Diameter cm	Filtre Uzunluğu Filter Length	Kapasite Capacity m ³ /h
IR-17074	2"	16	25 cm	20
IR-17075	2"	22	25 cm	25
IR-17076	2 1/2"	22	35 cm	30
IR-17077	3"	22	40 cm	40
IR-17078	4"	22	50 cm	50



Yatay Metal Filtreler Horizontal Metal Filter

Kod Code	Ebat Size	Çap Diameter cm	Filtre Uzunluğu Filter Length	Kapasite Capacity m ³ /h
IR-17126	2"	22	25 cm	20
IR-17127	2 1/2"	22	35 cm	30
IR-17128	3"	22	40 cm	40
IR-17129	4"	22	50 cm	50



Metal Hidrosiklonlar Metal Hydrocyclone

Kod Code	Ebat Size	Çap Diameter cm	Filtre Uzunluğu Filter Length	Kapasite Capacity m ³ /h
IR-17130	2"	22	220 cm	25
IR-17131	2 1/2"	28	280 cm	35
IR-17132	3"	28	280 cm	40
IR-17133	4"	28	280 cm	50
IR-17134	4"	32	320 cm	70
IR-17135	5"	38	380 cm	140
IR-17136	6"	45	450 cm	180



Gliserinli Manometre Pressure Gauge With Glycerine

Kod Code	Ebat Size	Paketleme-Koli Packaging-Box
IR-MAN-63-10	63/10 Bar - 1/4" Inlet Dia	50
IR-MAN-50-10	50/10 Bar - 1/4" Inlet Dia	50



Yatay Gübre Tankları Horizontal Fertilizer Tanks

Kod Code	Çap Diameter cm	Kapasite Litre Capacity Liter
IR-17091	45	100 Lt.
IR-17092	60	200 Lt.
IR-17093	60	300 Lt.
IR-17094	60	400 Lt.



Dikey Gübre Tankları Vertical Fertilizer Tank

Kod Code	Çap Diameter cm	Kapasite Litre Capacity Liter
IR-17087	28	30 Lt.
IR-17088	38	60 Lt.
IR-17089	45	100 Lt.
IR-17090	60	200 Lt.

Filtre Sistemleri
Filter System



Venturi Venture Tube

Kod Code	Ebat Size	Paketleme-Koli Packaging-Box
IR-VEN-3/4	¾"	12
IR-VEN-1	1"	10
IR-VEN-1 1/2	1½"	7
IR-VEN-2	2"	5

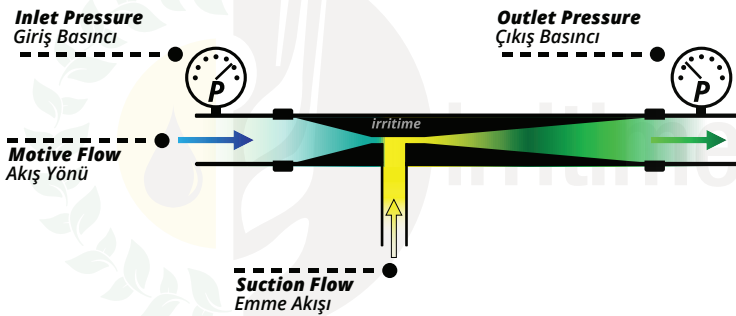

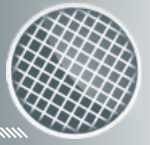

Gravel Tanklar Gravel (Media) Filters

Kod Code	Ebat Size	Çap Diameter inch	Kapasite Capacity m ³ /h
IR-17046	2"	18"	25
IR-17047	2 1/2"	24"	30
IR-17048	3"	24"	30
IR-17049	4"	24"	40
IR-17050	3"	36"	40
IR-17051	4"	36"	50



Ters Yıkamalı Graveller Gravel (Media) Filter Bypass Backflush

Kod Code	Ebat Size	Çap Diameter inch	Kapasite Capacity m ³ /h
IR-17153	2"	18"	25
IR-17154	2 1/2"	24"	30
IR-17155	3"	24"	30
IR-17156	4"	24"	40
IR-17157	3"	36"	40
IR-17158	4"	36"	50

Filtre Sistemleri
Filter System



Plastik Filtreli Ters Yıkamalı Graveller Gravels (Media) With Plastic Filter Bypass Backflush

Kod Code	Ebat Size	Çap Diameter inch	Kapasite Capacity m ³ /h
IR-17159	2"	18"	25
IR-17160	2 1/2"	24"	30
IR-17161	3"	24"	30
IR-17162	4"	24"	40
IR-17163	3"	36"	40
IR-17164	4"	36"	50

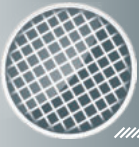

Ters Yıkamalı Çoklu Gravel Sistemler
Multiple Gravels (Media)
System Backflush

Kod Code	Ebat Size	Filtre Adet Filter Piece	Kapasite Capacity m ³ /h
IR-17120	4"	2/3" (24")	70
IR-17121	5"	3/3" (24")	105
IR-17122	6"	4/3" (24")	140
IR-17123	5"	2/3" (36")	90
IR-17124	6"	3/3" (36")	135
IR-17125	6"	4/3" (36")	160

Filtre Sistemleri
Filter System



İkiz Plastik Filteli Seperatör Sistemler
Separator System With
Double Plastic Filters

Kod Code	Ebat Size	Çap Diameter cm	Filtre Cinsi Filter Type	Kapasite Capacity m ³ /h
IR-17143	2"	28	Plastic Single Filter	25
IR-17144	2 1/2"	28		
IR-17145	3"	28		
IR-17146	4"	28		
IR-17147	3"	32	Plastic Double Filter	50
IR-17148	4"	32		

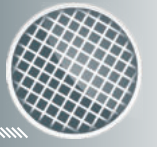

İkiz Plastik Filtreli Hidrosiklon Sistemler
**Hydrocyclon System With
Double Plastic Filter**

Kod Code	Ebat Size	Çap Diameter cm	Filtre Cinsi Filter Type	Kapasite Capacity m ³ /h
IR-17150	3"	32	PLASTIC DOUBLE FILTER	50
IR-17152	4"	32		70



Plastik Filtreli Hidrosiklon Sistemler
**Hydrocyclon System
With Plastic Filter**

Kod Code	Ebat Size	Çap Diameter cm	Filtre Cinsi Filter Type	Kapasite Capacity m ³ /h
IR-17062	2"	28	PLASTIC SINGLE FILTER	25
IR-17063	2 1/2"	28		35
IR-17064	3"	28		40
IR-17065	4"	28		50

YAĞMURLAMA SİSTEMLERİ SPRINKLER SYSTEMS

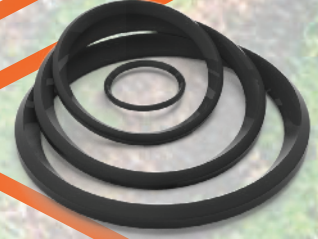



YAĞMURLAMA SİSTEMİ KURULUM PLANI

QUICK COUPLING SPRINKLER SYSTEM INSTALLATION DESIGN

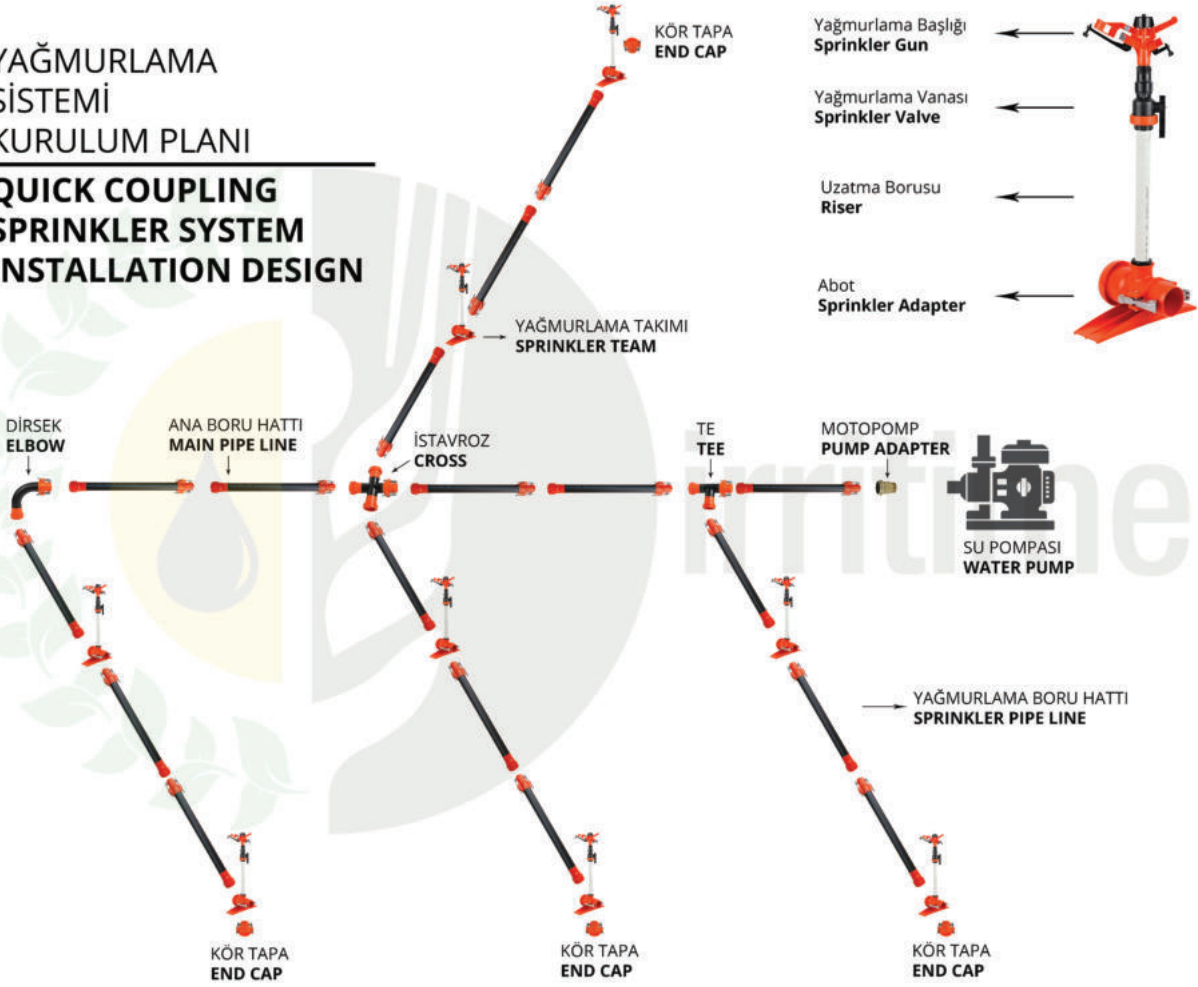

Özellikleri ve Faydaları

- 1) Yağmurlama Sistemi boruları plastik malzemeden imal edildiğinden dolayı arazide kolay taşıma için çok elverişlidir.
- 2) Yağmurlama Sulama sistemi mobil sistemdir. Bu nedenle, arazinin her yerine kurulum yapmanız gerekmez. Sabit Sulama Sisteminde böyle bir seçeneğiniz yoktur, çünkü her yere kurmanız gerekir.
- 3) Bu Sprinkler sistemini minimumdan maksimum boyuta kadar herhangi bir alanda kullanabilirsiniz. (Center Pivot Sistemi küçük araziler için pahalı sistemlerdir) Hızlı Bağlantı Sistemimiz, küçük arazileri olan küçük çiftçiler için avantaj sağlar.
- 4) Belirli bir alanı sularken, zaman kaybetmemek için diğer ikinci alanın borularını taşıyabilirsiniz.
- 5) Toprak işleme makinelerini ve traktörleri vb. araziye sokmak isterseniz, borunun bir kısmını sistemden çıkartıp makina ve traktörlerin çalışması için uygun alan oluşturabilirsiniz.
- 6) Sulama yapmak istediğiniz boruları şekilsiz arazilerin bir kısmında taşıyabilirsiniz.
- 7) Borular için ayrıca bir ek parça (Kablin Manşon) gereksiniminiz olmaz. Çünkü borular ek parçaları ile kaynatılmış olarak size gelir. Sabit sistemler de bu ek parçalara ihtiyacınız vardır.
- 8) Sulamayı sizin kontrolünüzdedir !! Yeteri kadar su ile sulama yapmak istediğiniz yeri sulayabilirsiniz. Suyu tasarrufu sağlarsınız.
- 9) Diğer yağmurlama sulama sistemlerinde suladığınız tüm mahsulleri bu sulama sistemi ile de sulayabilirsiniz.

Features and Benefits

- 1) Sprinkler system pipes are made of plastic material, making it very convenient for easy transport in the field.
- 2) Sprinkler Irrigation system is mobile system. Because of this you don't need to install everywhere of the land. In the Fixed Irrigation System you do not have such an option because you need to install it everywhere.
- 3) You can use this Sprinkler system in any area from minimum to maximum size. (Centre Pivot System is expensive systems for small lands) Our Quick Coupling Systems has advantage for small farmers who have small lands.
- 4) When irrigating a particular area, you can transport the pipes of the other second area so that you do not Flow time.
- 5) Soil cultivation machines and tractors and so on. If you want to get into the field, you can remove some of the pipe from the system and create a suitable area for the operation of machinery and tractors.
- 6) You can carry the pipes where you want to irrigate on part of formless lands
- 7) You don't need to use more fittings (couplings, saddles etc.) for pipes because pipes welded with their fittings completely. Fixed Irrigation Systems you need all these fittings with the pipes.
- 8) You can control the irrigation!! You can irrigate where you want to irrigate on lands with enough water. You save the water.
- 9) You can also irrigate all crops that you irrigate with other sprinkler irrigation systems.

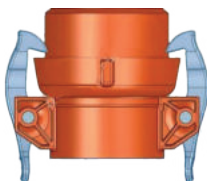

Bağlantı Şekli
Connection Type



5 - 6 Metre Yağmurlama Sulama Borusu 5 - 6 Meter Sprinkler Irrigation Pipe



Kod Code	Çap Diameter	Uzunluk Length
IR-50-5	50 mm - 1½"	5 mt
IR-50-6	50 mm - 1½"	6 mt
IR-63-5	63 mm - 2"	5 mt
IR-63-6	63 mm - 2"	6 mt
IR-75-5	75 mm - 2½"	5 mt
IR-75-6	75 mm - 2½"	6 mt
IR-90-5	90 mm - 3"	5 mt
IR-90-6	90 mm - 3"	6 mt
IR-110-5	110 mm - 4"	5 mt
IR-110-6	110 mm - 4"	6 mt
IR-125-5	125 mm - 5"	5 mt
IR-125-6	125 mm - 5"	6 mt
IR-140-5	140 mm - 5½"	5 mt
IR-140-6	140 mm - 5½"	6 mt
IR-160-5	160 mm - 6"	5 mt
IR-160-6	160 mm - 6"	6 mt

Yağmurlama Sistemleri
Sprinkler System

Abot Sprinkler Adapter



Kod Code	Ebat Size
IR-ABT 50	50 mm
IR-ABT 63	63 mm
IR-ABT 75	75 mm
IR-ABT 90	90 mm
IR-ABT 110	110 mm

Erkek Başlık Male Cap



Kod Code	Ebat Size
IR-MLC 50	50mm
IR-MLC 63	63mm
IR-MLC 75	75mm
IR-MLC 90	90mm
IR-MLC 110	110mm
IR-MLC 125	125mm
IR-MLC 140	140mm
IR-MLC 160	160mm

Dişli Başlık Female Cap

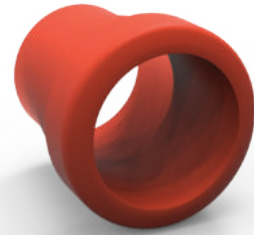

Kod Code	Ebat Size
IR-FLC 50	50mm
IR-FLC 63	63mm
IR-FLC 75	75mm
IR-FLC 90	90mm
IR-FLC 110	110mm
IR-FLC 125	125mm
IR-FLC 140	140mm
IR-FLC 160	160mm



Kod Code	Ebat Size
IR-CRS 50x50	50x50 mm
IR-CRS 63x63	63x63 mm
IR-CRS 75x63	75x63 mm
IR-CRS 75x75	75x75 mm
IR-CRS 90x75	90x75 mm
IR-CRS 90x90	90x90 mm
IR-CRS 110x50	110x50 mm
IR-CRS 110x63	110x63 mm
IR-CRS 110x75	110x75 mm
IR-CRS 110x90	110x90 mm
IR-CRS 110x110	110x110 mm
IR-CRS 125x63	125x63 mm
IR-CRS 125x75	125x75 mm
IR-CRS 125x90	125x90 mm
IR-CRS 125x110	125x110 mm
IR-CRS 125x125	125x125 mm
IR-CRS 140x75	140x75 mm
IR-CRS 140x90	140x90 mm
IR-CRS 140x110	140x110 mm
IR-CRS 140x125	140x125 mm
IR-CRS 140x140	140x140 mm
IR-CRS 160x75	160x75 mm
IR-CRS 160x90	160x90 mm
IR-CRS 160x110	160x110 mm
IR-CRS 160x125	160x125 mm
IR-CRS 160x140	160x140 mm
IR-CRS 160x160	160x160 mm

Istavroz
Cross



Kod Code	Ebat Size
IR-TEE 50x50	50x50x50 mm
IR-TEE 63x63	63x63x63 mm
IR-TEE 75x63	75x63x75 mm
IR-TEE 75x75	75x75x75 mm
IR-TEE 90x50	90x50x90 mm
IR-TEE 90x63	90x63x90 mm
IR-TEE 90x75	90x75x90 mm
IR-TEE 90x90	90x90x90 mm
IR-TEE 110x50	110x50x110 mm
IR-TEE 110x63	110x63x110 mm
IR-TEE 110x75	110x75x110 mm
IR-TEE 110x90	110x90x110 mm
IR-TEE 110x110	110x110x110 mm
IR-TEE 125x50	125x50x125 mm
IR-TEE 125x63	125x63x125 mm
IR-TEE 125x75	125x75x125 mm
IR-TEE 125x90	125x90x125 mm
IR-TEE 125x110	125x110x125 mm
IR-TEE 125x125	125x125x125 mm
IR-TEE 140x75	140x75x140 mm
IR-TEE 140x90	140x90x140 mm
IR-TEE 140x110	140x110x140 mm
IR-TEE 140x125	140x125x140 mm
IR-TEE 140x140	140x140x140 mm
IR-TEE 160x75	160x75x160 mm
IR-TEE 160x90	160x90x160 mm
IR-TEE 160x110	160x110x160 mm
IR-TEE 160x125	160x125x160 mm
IR-TEE 160x140	160x140x160 mm
IR-TEE 160x160	160x160x160 mm

Te
Tee



Dirsek Elbow



Kod Code	Ebat Size
IR-ELB 50	50x50 mm
IR-ELB 63	63x63 mm
IR-ELB 75	75x75 mm
IR-ELB 90	90x90 mm
IR-ELB 110	110x110 mm
IR-ELB 125	125x125 mm
IR-ELB 140	140x140 mm
IR-ELB 160	160x160 mm

Redüksiyon Reduction



Kod Code	Ebat Size
IR-RED 75x50	75x50 mm
IR-RED 75x63	75x63 mm
IR-RED 90x63	90x63 mm
IR-RED 90x75	90x75 mm
IR-RED 110x63	110x63 mm
IR-RED 110x75	110x75 mm
IR-RED 110x90	110x90 mm
IR-RED 125x63	125x63 mm
IR-RED 125x75	125x75 mm
IR-RED 125x90	125x90 mm
IR-RED 125x110	125x110 mm
IR-RED 140x75	140x75 mm
IR-RED 140x90	140x90 mm
IR-RED 140x110	140x110 mm
IR-RED 140x125	140x125 mm
IR-RED 160x90	160x90 mm
IR-RED 160x110	160x110 mm
IR-RED 160x125	160x125 mm
IR-RED 160x140	160x140 mm

Dişi Körtapa Female End Plug

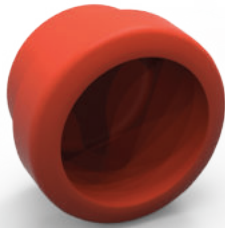

Kod Code	Ebat Size
IR-FEP 50	50 mm
IR-FEP 63	63 mm
IR-FEP 75	75 mm
IR-FEP 90	90 mm
IR-FEP 110	110 mm
IR-FEP 125	125 mm
IR-FEP 140	140 mm
IR-FEP 160	160 mm

Erkek Körtapa Male End Plug



Kod Code	Ebat Size
IR-MEP 50	50 mm
IR-MEP 63	63 mm
IR-MEP 75	75 mm
IR-MEP 90	90 mm
IR-MEP 110	110 mm
IR-MEP 125	125 mm
IR-MEP 140	140 mm
IR-MEP 160	160 mm



Conta
Gasket



Kod Code	Ebat Size
IR-GST 50	50 mm
IR-GST 63	63 mm
IR-GST 75	75 mm
IR-GST 90	90 mm
IR-GST 110	110 mm
IR-GST 125	125 mm
IR-GST 140	140 mm
IR-GST 160	160 mm

Hat Vanası
Line Valve



Kod Code	Ebat Size
IR-LNV 50	50 mm
IR-LNV 63	63 mm
IR-LNV 75	75 mm
IR-LNV 90	90 mm
IR-LNV 110	110 mm
IR-LNV 125	125 mm

Erkek Motopomp
Male Pump Adapter

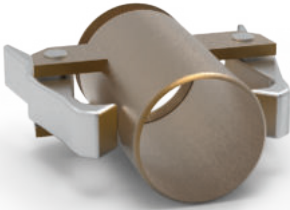

Kod Code	Ebat Size
IR-PSM 50	50 mm
IR-PSM 63	63 mm
IR-PSM 75	75 mm
IR-PSM 90	90 mm
IR-PSM 110	110 mm
IR-PSM 125	125 mm
IR-PSM 140	140 mm
IR-PSM 160	160 mm

Dişi Motopomp
Female Pump Adapter



Kod Code	Ebat Size
IR-PSF 50	50 mm
IR-PSF 63	63 mm
IR-PSF 75	75 mm
IR-PSF 90	90 mm
IR-PSF 110	110 mm
IR-PSF 125	125 mm
IR-PSF 140	140 mm
IR-PSF 160	160 mm



Sprink Vanası Sprinkler Valve



Kod Code	Ürün Çeşidi Type	Paketleme / Koli Packaging / Box
IR-ED-1	1" X 1" MALE-FEMALE VALVE 1" X 1" ERKEK-DİŞİ VANA	50

Manşonlar Adaptors



Kod Code	Ürün Çeşidi Type	Paketleme / Koli Packaging / Box
IR-1x1-FRN	1" Dişi 1" Dişi 1" Female 1" Female	300
IR-1x3/4-FRN	3/4" Dişi 1" Dişi 3/4" Female 1" Female	300
IR 1x1/2-FRN	1/2" Dişi 1" Dişi 1/2" Female 1" Female	300

Pe Turuncu Uzatma Borusu Pe Riser Orange



Kod Code	Ebat Size	Paketleme / Koli Packaging / Box
IR-PRO-25	1"- 25 cm	100
IR-PRO-50	1"- 50 cm	100

Pvc Beyaz Uzatma Borusu Pvc Riser White



Kod Code	Ebat Size	Paketleme / Koli Packaging / Box
IR-PRW-50	1"- 50 cm	100
IR-PRW-60	1"- 60 cm	100
IR-PRW-100	1"- 100 cm	100

Pvc Mavi Uzatma Borusu Pvc Riser Blue



Kod Code	Ebat Size	Paketleme / Koli Packaging / Box
IR-PRB-50	1"- 50 cm	100
IR-PRB-60	1"- 60 cm	100
IR-PRB-100	1"- 100 cm	100



Siyah Mini Sprink Black Mini Sprink

Kod Code	Ölçü Size	Meme Nozzle	Paketleme / Koli Packaging / box
IR-BMS-1/2	1/2"	2,5 x 3,5 mm	40
		2,0 x 3,0 mm	

Nozul Tipi Nozzle Type (mm)	Giriş Çapı Inlet Diameter (inch)	Basınç Pressure (bar)	Debi Flow Rate (l/h)	Sulama Çapı Irrigated Diameter (m)
2,5 x 3,5	1/2"	1,5	898	23
2,5 x 3,5	1/2"	2	1007	24
2,5 x 3,5	1/2"	2,5	1126	24
2,5 x 3,5	1/2"	3	1272	24,5
2,5 x 3,5	1/2"	3,5	1428	24,5
2 x 3	1/2"	1,5	656	22,5
2 x 3	1/2"	2	857	22,5
2 x 3	1/2"	2,5	898	22,5
2 x 3	1/2"	3	932	21,5
2 x 3	1/2"	3,5	1011	21,5



Turuncu Maksi Sprink Black Maxi Sprink

Kod Code	Ölçü Size	Meme Nozzle	Paketleme / Koli Packaging / box
IR-BMS-3/4	3/4"	2,3x3,8 mm	25
		4,5x5,0 mm	

Nozul Tipi Nozzle Type (mm)	Giriş Çapı Inlet Diameter (inch)	Basınç Pressure (bar)	Debi Flow Rate (l/h)	Sulama Çapı Irrigated Diameter (m)
4,5 x 5	3/4"	1,5	2140	24
4,5 x 5	3/4"	2	2360	25
4,5 x 5	3/4"	2,5	2690	25
4,5 x 5	3/4"	3	2890	26
4,5 x 5	3/4"	3,5	3140	27
2,3 x 3,8	3/4"	1,5	990	24,5
2,3 x 3,8	3/4"	2	1150	27
2,3 x 3,8	3/4"	2,5	1320	28
2,3 x 3,8	3/4"	3	1510	30
2,3 x 3,8	3/4"	3,5	1710	31



Gri Maksi Sprink Grey Maxi Sprink

Kod Code	Ölçü Size	Meme Nozzle	Paketleme / Koli Packaging / box
IR-GMS-1	1"	2,3x3,8 mm	25
		4,5x5,0 mm	

Nozul Tipi Nozzle Type (mm)	Giriş Çapı Inlet Diameter (inch)	Basınç Pressure (bar)	Debi Flow Rate (l/h)	Sulama Çapı Irrigated Diameter (m)
4,5 x 5	1"	2	2380	25
4,5 x 5	1"	2,5	2710	26
4,5 x 5	1"	3	2920	28,2
4,5 x 5	1"	3,5	3006	30
2,3 x 3,8	1"	2	1160	26,5
2,3 x 3,8	1"	2,5	1340	27,5
2,3 x 3,8	1"	3	1520	28,8
2,3 x 3,8	1"	3,5	1730	29,8



Siyah Açı Ayarlı Sprink Black Adjustable Sprink

Kod Code	Ölçü Size	Meme Nozzle	Paketleme / Koli Packaging / box
IR-BAS-3/4	3/4"	5 mm	25

Nozul Tipi Nozzle Type (mm)	Giriş Çapı Inlet Diameter (inch)	Basınç Pressure (bar)	Debi Flow Rate (l/h)	Sulama Çapı Irrigated Diameter (m)
5	3/4"	1,5	1380	24,8
5	3/4"	2	1520	25,3
5	3/4"	2,5	1730	26
5	3/4"	3	1860	26,4
5	3/4"	3,5	2020	27



B/2 Açılı Yağmurlama Başlığı B/2 Adjustable Raingun



Tip - Type	B/2 AÇILI YAĞMURLAMA BAŞLIĞI
Çalışma Basıncı - Recommended Pressure	2 - 5 kg/cm ²
Su Girişi - Inlet Diameter	1 1/2"
Ortalama Su Tüketimi - Water Requirement	5 - 15 m ³
Atış Mesafesi (Yarıçap) - Water Throw (Radius)	15 - 30 m
Açı Aralığı - Angle Distance	30° - 360°
Nozul Çapları mm - Nozzle Types mm	8x6 - 10x6 - 12x6

Kod Code	NOZUL NOZZLE mm	Çalışma Basıncı Working Pressure (ATM - BAR)	Debi Flow Rate (m ³ /h)	Atış Mesafesi Water Throw (Yarıçap-Radius m)	Yağmurlama Aralığı Sprinkler Distance		
					mm/h	mxm	
IR-B2ACI-86	8x6	2,0	4,90	19,50	11,34	8,51	6,81
		3,0	6,01	22,00	13,91	10,43	8,35
		4,0	6,91	24,00	16,00	12,00	9,60
		5,0	7,74	25,00	17,92	13,44	10,75
IR-B2ACI-106	10x6	2,0	6,77	21,50	15,67	11,75	9,40
		3,0	8,28	24,00	19,17	14,38	11,50
		4,0	9,68	26,50	22,18	16,63	13,31
		5,0	10,73	28,50	24,84	18,63	14,90
IR-B2ACI-126	12x6	2,0	9,07	23,00	21,00	15,75	12,60
		3,0	11,09	26,00	25,67	19,25	15,40
		4,0	12,82	28,50	28,68	22,26	17,80
		5,0	14,83	30,50	33,17	24,86	19,90



B/2 Açısız Yağmurlama Başlığı B/2 Full Circle Raingun



Tip - Type	B/2 AÇISIZ YAĞMURLAMA BAŞLIĞI
Çalışma Basıncı - Recommended Pressure	2 - 5 kg/cm ²
Su Girişi - Inlet Diameter	1 1/2"
Ortalama Su Tüketimi - Water Requirement	5 - 15 m ³
Atış Mesafesi (Yarıçap) - Water Throw (Radius)	15 - 30 m
Açı Aralığı - Angle Distance	0° - 360°
Nozul Çapları mm - Nozzle Types mm	8x6 - 10x6 - 12x6

Kod Code	NOZUL NOZZLE mm	Çalışma Basıncı Working Pressure (ATM - BAR)	Debi Flow Rate (m ³ /h)	Atış Mesafesi Water Throw (Yarıçap-Radius m)	Yağmurlama Aralığı Sprinkler Distance		
					mm/h	mxm	
IR-B2ASIZ-86	8x6	2,0	4,90	19,50	11,34	8,51	6,81
		3,0	6,01	22,00	13,91	10,43	8,35
		4,0	6,91	24,00	16,00	12,00	9,60
		5,0	7,74	25,00	17,92	13,44	10,75
IR-B2ASIZ-106	10x6	2,0	6,77	21,50	15,67	11,75	9,40
		3,0	8,28	24,00	19,17	14,38	11,50
		4,0	9,68	26,50	22,18	16,63	13,31
		5,0	10,73	28,50	24,84	18,63	14,90
IR-B2ASIZ-126	12x6	2,0	9,07	23,00	21,00	15,75	12,60
		3,0	11,09	26,00	25,67	19,25	15,40
		4,0	12,82	28,50	28,68	22,26	17,80
		5,0	14,83	30,50	33,17	24,86	19,90



Atilgan Açılı Yağmurlama Başlığı Atilgan Adjustable Raingun



Tip - Type	ATILGAN AÇILI YAĞMURLAMA BAŞLIĞI
Çalışma Basıncı - Recommended Pressure	2 - 5 kg/cm ²
Su Girişi - Inlet Diameter	1 1/2"
Ortalama Su Tüketimi - Water Requirement	5 - 15 m ³
Atış Mesafesi (Yarıçap) - Water Throw (Radius)	15 - 30 m
Açı Aralığı - Angle Distance	30° - 360°
Nozul Çapları mm - Nozzle Types mm	8x6 - 10x6 - 12x6

Kod Code	NOZUL NOZZLE mm	Çalışma Basıncı Working Pressure (ATM - BAR)	Debi Flow Rate (m ³ /h)	Atış Mesafesi Water Throw (Yarıçap-Radius m)	Yağmurlama Aralığı Sprinkler Distance		
					18x24	24x24	24x30
IR-ATILGAN-86	8x6	2,0	4,90	19,50	11,34	8,51	6,81
		3,0	6,01	22,00	13,91	10,43	8,35
		4,0	6,91	24,00	16,00	12,00	9,60
		5,0	7,74	25,00	17,92	13,44	10,75
IR-ATILGAN-106	10x6	2,0	6,77	21,50	15,67	11,75	9,40
		3,0	8,28	24,00	19,17	14,38	11,50
		4,0	9,68	26,50	22,18	16,63	13,31
		5,0	10,73	28,50	24,84	18,63	14,90
IR-ATILGAN-126	12x6	2,0	9,07	23,00	21,00	15,75	12,60
		3,0	11,09	26,00	25,67	19,25	15,40
		4,0	12,82	28,50	28,68	22,26	17,80
		5,0	14,83	30,50	33,17	24,86	19,90

Atilgan Junior Açılı Yağmurlama Başlığı Atilgan Junior Adjustable Raingun



Tip - Type	ATILGAN AÇILI YAĞMURLAMA BAŞLIĞI
Çalışma Basıncı - Recommended Pressure	2 - 5 kg/cm ²
Su Girişi - Inlet Diameter	1"
Ortalama Su Tüketimi - Water Requirement	5 - 10 m ³
Atış Mesafesi (Yarıçap) - Water Throw (Radius)	13 - 25 m
Açı Aralığı - Angle Distance	30° - 360°
Nozul Çapları mm - Nozzle Types mm	6x4 - 8x4 - 10x4

Kod Code	NOZUL NOZZLE	Çalışma Basıncı Working Pressure (ATM - BAR)	Debi Flow Rate (m ³ /h)	Sulanan Alan Irrigating Area (m ²)
IR-ATJUN-64	6x4	2,0	11,40	408
		3,0	13,20	547
		4,0	16,00	803
		5,0	18,10	1028
IR-ATJUN-84	8x4	2,0	13,50	572
		3,0	16,40	844
		4,0	19,65	1212
		5,0	22,80	1632
IR-ATJUN-104	10x4	2,0	15,60	764
		3,0	18,68	1095
		4,0	21,40	1437
		5,0	24,80	1931



1453 Açılı Plastik Başlığı 1453 Adjustable Raingun



Tip - Type	ATILGAN AÇILI YAĞMURLAMA BAŞLIĞI
Çalışma Basıncı - Recommended Pressure	2 - 5 kg/cm ²
Su Girişi - Inlet Diameter	1 ^{1/2} "
Ortalama Su Tüketimi - Water Requirement	5 - 25 m ³
Atış Mesafesi (Yarıçap) - Water Throw (Radius)	20 - 29 m
Açı Aralığı - Angle Distance	30° - 360°
Nozul Çapları mm - Nozzle Types mm	Standart-10-12-14-16

Kod Code	NOZUL NOZZLE	Çalışma Basıncı Working Pressure (ATM - BAR)	Debi Flow Rate (m ³ /h)	Atış Mesafesi Water Throw (Yarıçap-Radius m)
IR-1453-STN	STANDART	2,0	5,1	16
		3,0	5,9	17,5
		4,0	7,2	19,5
		5,0	8,4	21
IR-1453-10	10 mm	2,0	7,8	18
		3,0	9,5	21
		4,0	11	23
		5,0	12,4	24,5
IR-1453-12	12 mm	2,0	10,1	19,5
		3,0	12,4	22
		4,0	14,3	25
		5,0	16,1	27,5
IR-1453-14	14 mm	2,0	12,9	20,5
		3,0	15,8	23,5
		4,0	18,3	26
		5,0	20,5	28,5
IR-1453-16	16 mm	2,0	16	21
		3,0	19,6	24
		4,0	22,7	26,5
		5,0	24,8	29

***DIŞLİ BAĞLANTI* ELEMANLARI** **THREADED FITTINGS**

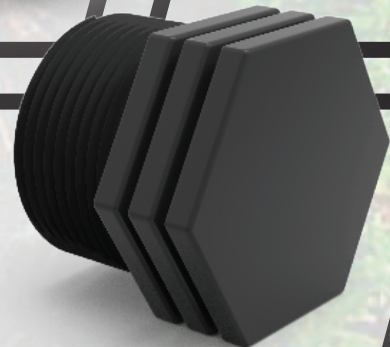
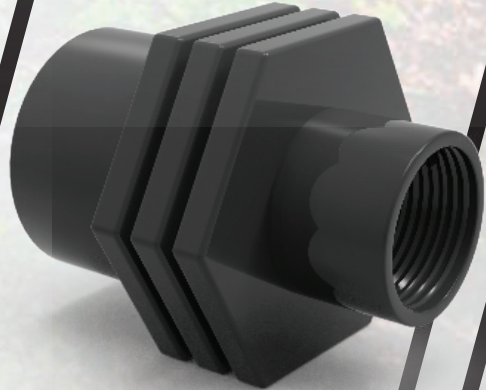
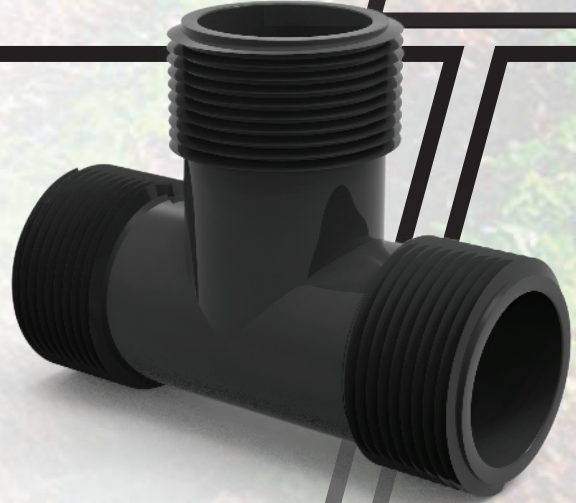
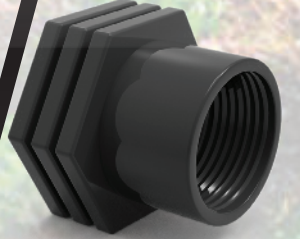
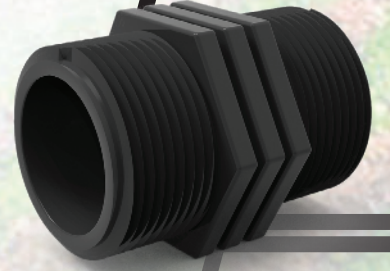



Kod Code	Pe Erkek Dişli Nipel Pe Male Nipple	Paketleme Packaging
IR-13511	½" X ½"	50
IR-13522	¾" X ¾"	50
IR-13533	1" X 1"	50
IR-13544	1¼" X 1¼"	25
IR-13555	1½" X 1½"	25
IR-13566	2" X 2"	25
IR-13577	2½" X 2½"	12
IR-13588	3" X 3"	12
IR-13599	4" X 4"	6

Kod Code	Pe Dişli Nipel Pe Female Nipple	Paketleme Packaging
IR-13711	½" X ½"	50
IR-13722	¾" X ¾"	50
IR-13733	1" X 1"	50
IR-13744	1¼" X 1¼"	25
IR-13755	1½" X 1½"	15
IR-13766	2" X 2"	12
IR-13777	2½" X 2½"	12
IR-13788	3" X 3"	6
IR-13799	4" X 4"	4

Kod Code	Pe Erkek Dişli Redüksiyon Nipel Pe Male Reduction Nipple	Paketleme Packaging
IR-13621	¾" X ½"	50
IR-13631	1" X ½"	50
IR-13632	1" X ¾"	50
IR-13641	1¼" X ½"	25
IR-13642	1¼" X ¾"	25
IR-13643	1¼" X 1"	25
IR-13652	1½" X ¾"	25
IR-13653	1½" X 1"	25
IR-13654	1½" X 1¼"	25
IR-13663	2" X 1"	25
IR-13664	2" X 1¼"	25
IR-13665	2" X 1½"	25
IR-13674	2½" X 1¼"	12
IR-13675	2½" X 1½"	12
IR-13676	2½" X 2"	12
IR-13685	3" X 1½"	12
IR-13686	3" X 2"	12
IR-13687	3" X 2½"	12
IR-13696	4" X 2"	6
IR-13697	4" X 2½"	6
IR-13698	4" X 3"	6



Kod Code	Pe Erkek Dişli Te Pe Male Tee	Paketleme Packaging
IR-13111	½" X ½" X ½"	25
IR-13112	½" X ¾" X ½"	25
IR-13121	¾" X ½" X ¾"	25
IR-13122	¾" X ¾" X ¾"	25
IR-13123	¾" X 1" X ¾"	25
IR-13131	1" X ½" X 1"	25
IR-13132	1" X ¾" X 1"	25
IR-13133	1" X 1" X 1"	25
IR-13141	1¼" X ½" X 1¼"	15
IR-13142	1¼" X ¾" X 1¼"	15
IR-13143	1¼" X 1" X 1¼"	15
IR-13144	1¼" X 1¼" X 1¼"	15
IR-13155	1½" X 1½" X 1½"	10
IR-13165	2" X 1½" X 2"	6
IR-13166	2" X 2" X 2"	6
IR-13177	2½" X 2½" X 2½"	3
IR-13188	3" X 3" X 3"	2
IR-13199	4" X 4" X 4"	1



Kod Code	Pe Erkek Dişli Dirsek Pe Male Elbow	Paketleme Packaging
IR-13311	½" X ½"	25
IR-13321	¾" X ½"	25
IR-13322	¾" X ¾"	25
IR-13331	1" X ½"	25
IR-13332	1" X ¾"	25
IR-13333	1" X 1"	25
IR-13341	1¼" X ½"	15
IR-13342	1¼" X ¾"	15
IR-13343	1¼" X 1"	15
IR-13344	1¼" X 1¼"	15
IR-13355	1½" X 1½"	10
IR-13364	2" X 1¼"	6
IR-13365	2" X 1½"	6
IR-13366	2" X 2"	6
IR-13377	2½" X 2½"	4
IR-13388	3" X 3"	2
IR-13399	4" X 4"	1

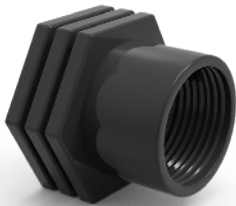

Kod Code	Pe Dişi Körtapa Pe Female End Cap	Paketleme Packaging
IR-14211	½"	50
IR-14222	¾"	50
IR-14233	1"	50



PP EK PARÇALAR PP COMPRESSION FITTINGS



Kod Code	Pe Erkek-Dişi Redüksiyon Nipel Pe Male-Female Reduction Nipple	Paketleme Packaging
IR-13911	½" X ½"	50
IR-13912	½" X ¾"	50
IR-13913	½" X 1"	50
IR-13922	¾" X ¾"	50
IR-13923	¾" X 1"	50
IR-13933	1" X 1"	50
IR-13944	1¼" X 1¼"	15
IR-13945	1¼" X 1½"	15
IR-13955	1½" X 1½"	15
IR-13956	1½" X 2"	15
IR-13957	1½" X 2½"	15
IR-13966	2" X 2"	15
IR-13967	2" X 2½"	12
IR-13968	2" X 3"	6
IR-13969	2" X 4"	4
IR-13977	2½" X 2½"	12
IR-13978	2½" X 3"	6
IR-13979	2½" X 4"	4
IR-13988	3" X 3"	6
IR-13989	3" X 4"	4
IR-13999	4" X 4"	4



Kod Code	Pe Dişi Redüksiyon Nipeli Pe Female Reduction Nipple	Paketleme Packaging
IR-13821	¾" X ½"	50
IR-13831	1" X ½"	50
IR-13832	1" X ¾"	50
IR-13842	1¼" X ¾"	25
IR-13843	1¼" X 1"	25
IR-13853	1½" X 1"	15
IR-13854	1½" X 1¼"	15
IR-13864	2" X 1¼"	12
IR-13865	2" X 1½"	12
IR-13874	2½" X 1¼"	12
IR-13875	2½" X 1½"	12
IR-13876	2½" X 2"	12
IR-13886	3" X 2"	6
IR-13887	3" X 2½"	6
IR-13896	4" X 2"	4
IR-13897	4" X 2½"	4
IR-13898	4" X 3"	4

PE Ek Parçalar
PE Compression Fittings



Kod Code	Pe Dişi Te Pe Female Tee	Paketleme Packaging
IR-13271	½" X ½" X ½"	25
IR-13272	¾" X ¾" X ¾"	25
IR-13273	1" X 1" X 1"	25
IR-13274	1¼" X 1¼" X 1¼"	15
IR-13275	1½" X 1½" X 1½"	10
IR-13276	2" X 2" X 2"	6
IR-13277	2½" X 2½" X 2½"	3
IR-13278	3" X 3" X 3"	2
IR-13279	4" X 4" X 4"	1

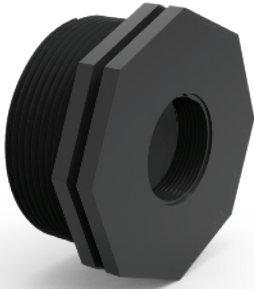

Kod Code	Pe Erkek-Dişi Redüksiyon Nipel Pe Male - Female Reduction Nipple	Paketleme Packaging
IR-13921	¾" X ½"	50
IR-13931	1" X ½"	50
IR-13932	1" X ¾"	50
IR-13941	1¼" X ½"	25
IR-13942	1¼" X ¾"	25
IR-13943	1¼" X 1"	25
IR-13951	1½" X ½"	15
IR-13952	1½" X ¾"	15
IR-13953	1½" X 1"	15
IR-13954	1½" X 1¼"	15
IR-13961	2" X ½"	15
IR-13962	2" X ¾"	15
IR-13963	2" X 1"	15
IR-13964	2" X 1¼"	15
IR-13965	2" X 1½"	15
IR-13973	2½" X 1"	12
IR-13974	2½" X 1¼"	12
IR-13975	2½" X 1½"	12
IR-13976	2½" X 2"	12
IR-13984	3" X 1¼"	12
IR-13985	3" X 1½"	12
IR-13986	3" X 2"	12
IR-13987	3" X 2½"	12
IR-13996	4" X 2"	6
IR-13997	4" X 2½"	6
IR-13998	4" X 3"	6



PP EK PARÇALAR PP COMPRESSION FITTINGS



Kod Code	Pe Erkek Dişi Te Pe Male - Female - Male Tee	Paketleme Packaging
IR-13211	½" X ½" X ½"	25
IR-13212	½" X ¾" X ½"	25
IR-13221	¾" X ½" X ¾"	25
IR-13222	¾" X ¾" X ¾"	25
IR-13223	¾" X 1" X ¾"	25
IR-13231	1" X ½" X 1"	25
IR-13232	1" X ¾" X 1"	25
IR-13233	1" X 1" X 1"	25
IR-13242	1¼" X ¾" X 1¼"	15
IR-13243	1¼" X 1" X 1¼"	15
IR-13254	1½" X 1¼" X 1½"	10
IR-13255	1½" X 1½" X 1½"	10
IR-13264	2" X 1¼" X 2"	6
IR-13265	2" X 1½" X 2"	6
IR-13266	2" X 2" X 2"	6
IR-13267	2½" X 2½" X 2½"	3
IR-13268	3" X 3" X 3"	2
IR-13269	4" X 4" X 4"	1



Kod Code	Pe Dişi Dirsek Pe Female Elbow	Paketleme Packaging
IR-13471	½" X ½"	25
IR-13472	¾" X ¾"	25
IR-13473	1" X 1"	25
IR-13474	1¼" X 1¼"	15
IR-13475	1½" X 1½"	10
IR-13476	2" X 2"	6
IR-13477	2½" X 2½"	4
IR-13478	3" X 3"	2
IR-13479	4" X 4"	1

PE Ek Parçalar
PE Compression Fittings

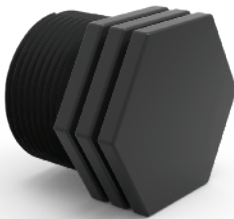

Kod Code	Pe Erkek Kör Tapa Pe Male And Cap	Paketleme Packaging
IR-14111	½"	50
IR-14122	¾"	50
IR-14133	1"	50
IR-14144	1¼"	25
IR-14155	1½"	15
IR-14166	2"	12
IR-14177	2½"	12
IR-14188	3"	6
IR-14199	4"	4



KABLİN EK PARÇALAR **COUPLING FITTINGS**

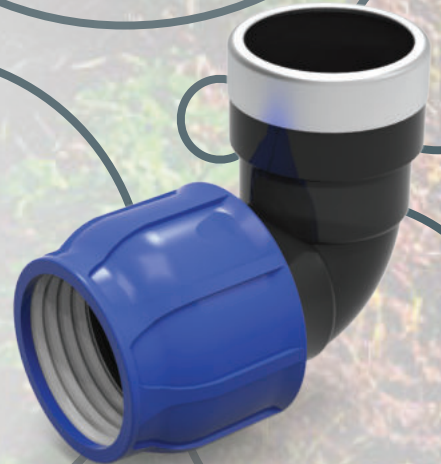
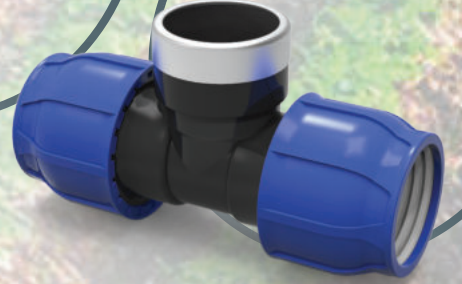



PP EK PARÇALAR PP COMPRESSION FITTINGS



Kod Code	Erkek Kablin Male Adaptor	Paketleme Packaging
IR-10001011	20 X 1/2"	50
IR-10001012	20 X 3/4"	50
IR-10001021	25 X 1/2"	25
IR-10001022	25 X 3/4"	25
IR-10001023	25 X 1"	25
IR-10001031	32 X 1/2"	25
IR-10001032	32 X 3/4"	25
IR-10001033	32 X 1"	25
IR-10001034	32 X 1 1/4"	25
IR-10001043	40 X 1"	15
IR-10001044	40 X 1 1/4"	15
IR-10001045	40 X 1 1/2"	15
IR-10001054	50 X 1 1/4"	10
IR-10001055	50 X 1 1/2"	10
IR-10001056	50 X 2"	10
IR-10001065	63 X 1 1/2"	6
IR-10001066	63 X 2"	6
IR-10001067	63 X 2 1/2"	6
IR-10001076	75 X 2"	4
IR-10001077	75 X 2 1/2"	4
IR-10001078	75 X 3"	4
IR-10001086	90 X 2 1/2"	4
IR-10001087	90 X 2"	4
IR-10001088	90 X 3"	4
IR-10001089	90 X 4"	4
IR-10001095	110 X 2"	2
IR-10001096	110 X 2 1/2"	2
IR-10001097	110 X 3"	2
IR-10001098	110 X 4"	2

PP Ek Parçalar
PP Compression Fittings



Kod Code	Kablin Manşon Coupling	Paketleme Packaging
IR-10002011	20 X 20	25
IR-10002022	25 X 25	25
IR-10002033	32 X 32	10
IR-10002044	40 X 40	10
IR-10002055	50 X 50	6
IR-10002066	63 X 63	5
IR-10002077	75 X 75	2
IR-10002088	90 X 90	2
IR-10002099	110 X 110	1





Kod Code	Dışı Kablin Female Adaptor	Paketleme Packaging
IR-10008111	20 X ½"	50
IR-10008112	20 X ¾"	50
IR-10008121	25 X ½"	25
IR-10008122	25 X ¾"	25
IR-10008123	25 X 1"	25
IR-10008132	32 X ¾"	25
IR-10008133	32 X 1"	25
IR-10008134	32 X 1¼"	25
IR-10008143	40 X 1"	15
IR-10008144	40 X 1¼"	15
IR-10008145	40 X 1½"	15
IR-10008154	50 X 1¼"	10
IR-10008155	50 X 1½"	10
IR-10008156	50 X 2"	10
IR-10008165	63 X 1½"	6
IR-10008166	63 X 2"	6
IR-10008167	63 X 2½"	6
IR-10008176	75 X 2"	4
IR-10008177	75 X 2½"	4
IR-10008178	75 X 3"	4
IR-10008186	90 X 2"	4
IR-10008187	90 X 2½"	4
IR-10008188	90 X 3"	4
IR-10008189	90 X 4"	4
IR-10008195	110 X 2"	2
IR-10008196	110 X 2½"	2
IR-10008197	110 X 3"	2
IR-10008198	110 X 4"	2



Kod Code	Kablin Dirsek Coupling Elbow	Paketleme Packaging
IR-10004011	20 X 20	25
IR-10004022	25 X 25	15
IR-10004033	32 X 32	10
IR-10004044	40 X 40	5
IR-10004055	50 X 50	4
IR-10004066	63 X 63	4
IR-10004077	75 X 75	2
IR-10004088	90 X 90	1
IR-10004099	110 X 110	1



Kod Code	Kablin Redüksiyon Coupling Reducing	Paketleme Packaging
IR-10006021	25 x 20	25
IR-10006031	32 x 20	10
IR-10006032	32 x 25	10
IR-10006041	40 x 20	10
IR-10006042	40 x 25	10
IR-10006043	40 x 32	10
IR-10006052	50 x 25	6
IR-10006053	50 x 32	6
IR-10006054	50 x 40	6
IR-10006062	63 x 25	6
IR-10006063	63 x 32	6
IR-10006064	63 x 40	6
IR-10006065	63 x 50	6
IR-10006075	75 x 50	2
IR-10006076	75 x 63	2
IR-10006086	90 x 63	2
IR-10006087	90 x 75	2
IR-10006096	110x63	1
IR-10006097	110 x 75	1
IR-10006098	110 x 90	1

PP Ek Parçalar
PP Compression Fittings



Kod Code	Kablin Körtapa End Cap	Paketleme Packaging
IR-10007011	20	50
IR-10007022	25	25
IR-10007033	32	25
IR-10007044	40	15
IR-10007055	50	12
IR-10007066	63	6
IR-10007077	75	4
IR-10007088	90	4
IR-10007099	110	2



Kod Code	Kablin Manşon Te Coupling Tee	Paketleme Packaging
IR-10002511	20 x 20 x 20	15
IR-10002522	25 x 25 x 25	10
IR-10002533	32 x 32 x 32	5
IR-10002544	40 x 40 x 40	5
IR-10002555	50 x 50 x 50	4
IR-10002566	63 x 63 x 63	3
IR-10002577	75 x 75 x 75	1
IR-10002588	90 x 90 x 90	1
IR-10002599	110 x 110 x 110	1



Kod Code	Kablin Erkek Te Coupling Male Tee	Paketleme Packaging
IR-10003011	20 x ½" x 20	15
IR-10003012	20 x ¾" x 20	15
IR-10003021	25 x ½" x 25	10
IR-10003022	25 x ¾" x 25	10
IR-10003023	25 x 1" x 25	10
IR-10003032	32 x ¾" x 32	10
IR-10003033	32 x 1" x 32	10
IR-10003034	32 x 1¼" x 32	10
IR-10003043	40 x 1" x 40	5
IR-10003044	40 x 1¼" x 40	5
IR-10003045	40 x 1½" x 40	5
IR-10003053	50 x 1" x 50	4
IR-10003054	50 x 1¼" x 50	4
IR-10003055	50 x 1½" x 50	4
IR-10003056	50 x 2" x 50	4
IR-10003064	63 x 1¼" x 63	3
IR-10003065	63 x 1½" x 63	3
IR-10003066	63 x 2" x 63	3
IR-10003067	63 x 2½" x 63	3
IR-10003076	75 x 2" x 75	1
IR-10003077	75 x 2½" x 75	1
IR-10003078	75 x 3" x 75	1
IR-10003086	90 x 2" x 90	1
IR-10003087	90 x 2½" x 90	1
IR-10003088	90 x 3" x 90	1
IR-10003089	90 x 4" x 90	1
IR-10003096	110 x 2½" x 110	1
IR-10003097	110 x 3" x 110	1
IR-10003098	110 x 4" x 110	1



PP EK PARÇALAR PP COMPRESSION FITTINGS



Kod Code	Kablin Dişi Te Coupling Female Tee	Paketleme Packaging
IR-10008311	20 x ½" x 20	15
IR-10008312	20 x ¾" x 20	15
IR-10008321	25 x ½" x 25	10
IR-10008322	25 x ¾" x 25	10
IR-10008323	25 x 1" x 25	10
IR-10008331	32 x ½" x 32	10
IR-10008332	32 x ¾" x 32	10
IR-10008333	32 x 1" x 32	10
IR-10008334	32 x 1¼" x 32	10
IR-10008342	40 x ¾" x 40	5
IR-10008343	40 x 1" x 40	5
IR-10008344	40 x 1¼" x 40	5
IR-10008345	40 x 1½" x 40	5
IR-10008352	50 x ¾" x 50	4
IR-10008353	50 x 1" x 50	4
IR-10008354	50 x 1¼" x 50	4
IR-10008355	50 x 1½" x 50	4
IR-10008356	50 x 2" x 50	4
IR-10008363	63 x 1" x 63	3
IR-10008364	63 x 1¼" x 63	3
IR-10008365	63 x 1½" x 63	3
IR-10008366	63 x 2" x 63	3
IR-10008367	63 x 2½" x 63	3
IR-10008376	75 x 2" x 75	1
IR-10008377	75 x 2½" x 75	1
IR-10008378	75 x 3" x 75	1
IR-10008387	90 x 2½" x 90	1
IR-10008388	90 x 3" x 90	1
IR-10008389	90 x 4" x 90	1
IR-10008396	110 x 2½" x 110	1
IR-10008397	110 x 3" x 110	1
IR-10008398	110 x 4" x 110	1

PP Ek Parçalar
PP Compression Fittings



Kod Code	Kablin Redüksiyon Dirsek Reducing Elbow	Paketleme Packaging
IR-10006521	25 x 20	15
IR-10006532	32 x 25	10
IR-10006543	40 x 32	5
IR-10006554	50 x 40	4
IR-10006565	63 x 50	4
IR-10006576	75 x 63	2
IR-10006587	90 x 75	1
IR-10006598	110 x 90	1



Kod Code	Kablin Redüksiyon Te Coupling Reducing Tee	Paketleme Packaging
IR-10005521	25 x 20 x 25	10
IR-10005531	32 x 20 x 32	5
IR-10005532	32 x 25 x 32	5
IR-10005542	40 x 25 x 40	5
IR-10005543	40 x 32 x 40	5
IR-10005552	50 x 25 x 50	4
IR-10005553	50 x 32 x 50	4
IR-10005554	50 x 40 x 50	4
IR-10005562	63 x 25 x 63	3
IR-10005563	63 x 32 x 63	3
IR-10005564	63 x 40 x 63	3
IR-10005565	63 x 50 x 63	3
IR-10005575	75 x 50 x 75	1
IR-10005576	75 x 63 x 75	1
IR-10005586	90 x 63 x 90	1
IR-10005587	90 x 75 x 90	1
IR-10005596	110 x 63 x 110	1
IR-10005597	110 x 75 x 110	1
IR-10005598	110 x 90 x 110	1



Kod Code	Kablin Dişi Dirsek Coupling Female Elbow	Paketleme Packaging
IR-10008511	20 x ½"	600
IR-10008512	20 x ¾"	550
IR-10008521	25 x ½"	420
IR-10008522	25 x ¾"	360
IR-10008523	25 x 1"	330
IR-10008532	32 x ¾"	220
IR-10008533	32 x 1"	240
IR-10008534	32 x 1¼"	190
IR-10008543	40 x 1"	130
IR-10008544	40 x 1¼"	130
IR-10008545	40 x 1½"	110
IR-10008554	50 x 1¼"	88
IR-10008555	50 x 1½"	80
IR-10008556	50 x 2"	68
IR-10008565	63 x 1½"	44
IR-10008566	63 x 2"	48
IR-10008567	63 x 2½"	40
IR-10008576	75 x 2"	32
IR-10008577	75 x 2½"	30
IR-10008578	75 x 3"	28
IR-10008587	90 x 2½"	18
IR-10008588	90 x 3"	18
IR-10008589	90 x 4"	16
IR-10008597	110 x 3"	11
IR-10008598	110 x 4"	10



Kod Code	Kablin Erkek Dirsek Coupling Male Elbow	Paketleme Packaging
IR-10004511	20 x 1/2"	25
IR-10004512	20 x 3/4"	25
IR-10004521	25 x 1/2"	15
IR-10004522	25 x 3/4"	15
IR-10004523	25 x 1"	15
IR-10004532	32 x 3/4"	10
IR-10004533	32 x 1"	10
IR-10004534	32 x 1 1/4"	10
IR-10004543	40 x 1"	5
IR-10004544	40 x 1 1/4"	5
IR-10004545	40 x 1 1/2"	5
IR-10004554	50 x 1 1/4"	4
IR-10004555	50 x 1 1/2"	4
IR-10004556	50 x 2"	4
IR-10004565	63 x 1 1/2"	4
IR-10004566	63 x 2"	4
IR-10004567	63 x 2 1/2"	4
IR-10004576	75 x 2"	2
IR-10004577	75 x 2 1/2"	2
IR-10004578	75 x 3"	2
IR-10004587	90 x 2 1/2"	1
IR-10004588	90 x 3"	1
IR-10004589	90 x 4"	1
IR-10004597	110 x 3"	1
IR-10004598	110 x 4"	1



Kod Code	Kablin Anahtarı Coupling Key	Paketleme Packaging
IR-10009511	20 mm	25
IR-10009522	25 mm	25
IR-10009533	32 mm	15
IR-10009544	40 mm	15
IR-10009555	50 mm	15
IR-10009566	63 mm	10
IR-10009577	75 mm	10
IR-10009588	90 mm	10
IR-10009599	110 mm	5



Kod Code	Priz Kolye Clamp Saddle Bolted	Paketleme Packaging
IR-100120201	25 x ½"	25
IR-100120301	32 x ½"	25
IR-100120302	32 x ¾"	25
IR-100120401	40 x ½"	25
IR-100120402	40 x ¾"	25
IR-100120501	50 x ½"	10
IR-100120502	50 x ¾"	10
IR-100120503	50 x 1"	10
IR-100120601	63 x ½"	10
IR-100120602	63 x ¾"	10
IR-100120603	63 x 1"	10
IR-100120604	63 x 1 ¼"	10
IR-100120605	63 x 1 ½"	10
IR-100120701	75 x ½"	5
IR-100120702	75 x ¾"	5
IR-100120703	75 x 1"	5
IR-100120704	75 x 1 ¼"	5
IR-100120705	75 x 1 ½"	5
IR-100120706	75 x 2"	5
IR-100120801	90 x ½"	5
IR-100120802	90 x ¾"	5
IR-100120803	90 x 1"	5
IR-100120804	90 x 1 ¼"	5
IR-100120805	90 x 1 ½"	5
IR-100120806	90 x 2"	5
IR-100120901	110 x ½"	5
IR-100120902	110 x ¾"	5
IR-100120903	110 x 1"	5
IR-100120904	110 x 1 ¼"	5
IR-100120905	110 x 1 ½"	5
IR-100120906	110 x 2"	5



Kod Code	Çift Çikiş Priz Kolye Dubble Clamp Saddle (Bolted)	Paketleme Packaging
IR-100140201	25 x 1/2" x 1/2"	25
IR-100140301	32 x 1/2" x 1/2"	25
IR-100140302	32 x 3/4" x 3/4"	25
IR-100140401	40 x 1/2" x 1/2"	25
IR-100140402	40 x 3/4" x 3/4"	25
IR-100140501	50 x 1/2" x 1/2"	10
IR-100140502	50 x 1/2" x 1/2"	10
IR-100140503	50 x 1" x 1"	10
IR-100140601	63 x 1/2" x 1/2"	10
IR-100140602	63 x 3/4" x 3/4"	10
IR-100140603	63 x 1" x 1"	10
IR-100140604	63 x 1 1/4" x 1 1/4"	10
IR-100140605	63 x 1 1/2" x 1 1/2"	10
IR-100140701	75 x 1/2" x 1/2"	5
IR-100140702	75 x 3/4" x 3/4"	5
IR-100140703	75 x 1" x 1"	5
IR-100140704	75 x 1 1/4" x 1 1/4"	5
IR-100140705	75 x 1 1/2" x 1 1/2"	5
IR-100140706	75 x 2" x 2"	5
IR-100140801	90 x 1/2" x 1/2"	5
IR-100140802	90 x 3/4" x 3/4"	5
IR-100140803	90 x 1" x 1"	5
IR-100140804	90 x 1 1/4" x 1 1/4"	5
IR-100140805	90 x 1 1/2" x 1 1/2"	5
IR-100140806	90 x 2" x 2"	5
IR-100140901	110 x 1/2" x 1/2"	5
IR-100140902	110 x 3/4" x 3/4"	5
IR-100140903	110 x 1" x 1"	5
IR-100140904	110 x 1 1/4" x 1 1/4"	5
IR-100140905	110 x 1 1/2" x 1 1/2"	5
IR-100140906	110 x 2" x 2"	5

VANALAR VALVES





PP EK PARÇALAR PP COMPRESSION FITTINGS



Kod Code	PP Kablin Küresel Vana PP Coupling Ball Valve	PN	Paketleme Packaging
IR-995711	20 X 20	10	10
IR-995722	25 X 25	10	6
IR-995733	32 X 32	10	5
IR-995744	40 X 40	10	5
IR-995755	50 X 50	10	5
IR-995766	63 X 63	10	2



Kod Code	PP Kablin Dişi Küresel Vana PP Coupling-Female Ball Valve	PN	Paketleme Packaging
IR-994711	20 X ½"	10	10
IR-994722	25 X ¾"	10	6
IR-994733	32 X 1"	10	5
IR-994744	40 X 1¼"	10	5
IR-994755	50 X 1½"	10	4
IR-994766	63 X 2"	10	2



Kod Code	PP Dişi-Dişi Küresel Vana PP Female-Female Ball Valve	PN	Paketleme Packaging
IR-993711	½"x½"	10	10
IR-993722	¾"x¾"	10	10
IR-993733	1" x 1"	10	10
IR-993744	1 ¼" x 1 ¼"	10	6
IR-993755	1 ½" x 1 ½"	10	6
IR-993766	2" x 2"	10	4
IR-993777	2 ½" x 2 ½"	6	2
IR-993788	3" x 3"	6	2
IR-993799	4" x 4"	6	2



Kod Code	Pvc Küresel Vana Pvc Ball Valve	Paketleme Packaging
IR-PVC-1/2	½"	75
IR-PVC-3/4	¾"	65
IR-PVC-1	1"	50
IR-PVC-11/4	1¼"	45
IR-PVC-11/2	1½"	40
IR-PVC-2	2"	30
IR-PVC-21/2	2½"	25
IR-PVC-3	3"	15
IR-PVC-4	4"	8



Kod Code	Çelik Kollu Küresel Vana Stel Arm Pvc Ball Valve	Paketleme Packaging
IR-001	2"	100
IR-00125	2½"	100
IR-0013	3"	100
IR-0014	4"	100

PP Ek Parçalar
PP Compression Fittings



Kod Code	PP Kablo Küresel Vana PP Coupling Ball Valve	PN	Paketleme Packaging
IR-99544	40 x 40	10	4
IR-99555	50 x 50	10	2
IR-99566	63 x 63	10	2



Kod Code	PP Kablo-Dişi Küresel Vana PP Coupling-Female Ball Valve	PN	Paketleme Packaging
IR-99432	32 x ¾"	10	4
IR-99433	32 x 1"	10	4
IR-99443	40 x 1"	10	4
IR-99444	40 x 1 ¼"	10	4
IR-99454	50 x 1 ¼"	10	2
IR-99455	50 x 1 ½"	10	2
IR-99465	63 x 1 ½"	10	2
IR-99466	63 x 2 "	10	2



Kod Code	PP Kablo Erkek Küresel Vana PP Coupling-Male Ball Valve	PN	Paketleme Packaging
IR-99234	1" x 40	10	4
IR-99244	1 ¼" x 40	10	4
IR-99245	1 ¼" x 50	10	2
IR-99255	1 ½" x 50	10	2
IR-99256	1 ½" x 63	10	2
IR-99266	2" x 63	10	2



Kod Code	PP Dişi Küresel Vana PP Female Ball Valve	PN	Paketleme Packaging
IR-99322	¾" x ¾"	10	4
IR-99332	1" x ¾"	10	4
IR-99333	1" x 1"	10	4
IR-99343	1 ¼" x 1"	10	4
IR-99344	1 ¼" x 1 ¼"	10	4
IR-99354	1 ½" x 1 ¼"	10	2
IR-99355	1 ½" x 1 ½"	10	2
IR-99365	2" x 1 ½"	10	2
IR-99366	2" x 2 "	10	2



PP EK PARÇALAR PP COMPRESSION FITTINGS



Kod Code	PP Erkek - Dişi Küresel Vana PP Male - Female Ball Valve	PN	Paketleme Packaging
IR-99122	¾" x ¾"	10	4
IR-99123	¾" x 1"	10	4
IR-99132	1" x ¾"	10	4
IR-99133	1" x 1"	10	4
IR-99134	1" x 1 ¼"	10	4
IR-99143	1 ¼" x 1"	10	4
IR-99144	1 ¼" x 1 ¼"	10	4
IR-99145	1 ¼" x 1 ½"	10	2
IR-99154	1 ½" x 1 ¼"	10	2
IR-99155	1 ½" x 1 ½"	10	2
IR-99156	1 ½" x 2"	10	2
IR-99165	2" x 1 ½"	10	2
IR-99166	2" x 2"	10	2

KEY



VALVE

Kod Code	Can Suyu Musluğu ve Anahtarı Quick Coupling Valve With Key	Paketleme Packaging
IR-6405-V	Musluk - Valve	100
IR-6405-K	Anahtar - Key	100



Kod Code	Vana Kutusu Valve Box	Paketleme Packaging
IR-73006	6"	1



Kod Code	Vana Kutusu Valve Box	Paketleme Packaging
IR-73010	10"	1

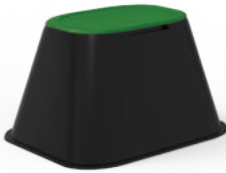

Kod Code	Vana Kutusu Valve Box	Paketleme Packaging
IR-73012	12"	1



Kod Code	Vana Kutusu Jumbo Valve Box	Paketleme Packaging
IR-73014	14"	1

PP Ek Parçalar
PP Compression Fittings





DAMLA SULAMA BORUSU
DRIP IRRIGATION PIPE

DAMLAMA EK PARÇALARI
DRIP IRRIGATION FITTINGS

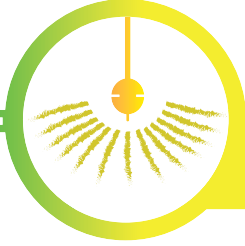

MİKRO YAĞMURLAMA SİSTEMLERİ
MICRO SPRINKLER

FİLTRE SİSTEMLERİ
FILTER SYSTEMS

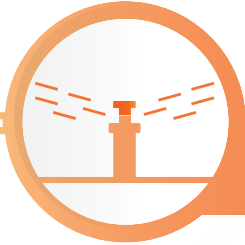
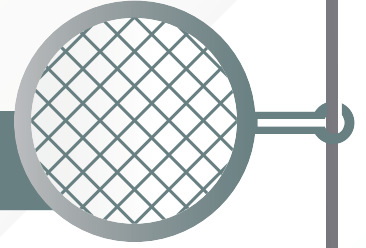

YAĞMURLAMA SİSTEMLERİ
SPRINKLER SYSTEMS

PP DIŞLI EK PARÇALAR
PP THREADED FITTINGS

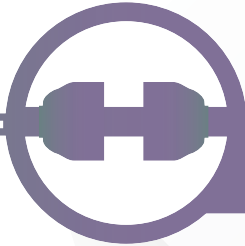
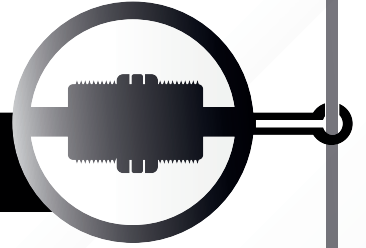

PP EK PARÇALAR
PP COMPRESSION FITTINGS



Fevzi Çakmak Mahallesi
10762. Sokak No : 2D
Karatay / KONYA



+90 (332) 502 27 95



info@irritime.com



/ www.irritime.com



irritime